



# VALIDATED FILTRATION SOLUTIONS FOR INDUSTRY LEADERS®

High-quality products with innovative designs that meet every challenge for our global customer base.



# TABLE OF CONTENTS

## Our Company

Filtration Group .....	3
About Us .....	4
Industries Served .....	5

## Our Product Series

<b>Cartridge End Cap Configurations .....</b>	<b>7</b>
<b>Pleated Cartridges .....</b>	<b>8</b>
PP-Series .....	9
PPE-Series .....	10
FG-Series .....	11
FGE-Series .....	12
PEE-Series .....	13
LiquidClear™ GF-Series .....	14
GFH-Series .....	15
<b>Pleated Membrane Cartridges .....</b>	<b>16</b>
GHPS-Series .....	17
GWPE-Series .....	18
WCPE-Series .....	19
GGPE-Series .....	20
GEPES-Series .....	21
GFPES-Series .....	22
GBPES-Series .....	23
GDPE-Series .....	24
GSPE-Series .....	25
BRPE-Series .....	26
PPES-Series .....	27
GGHNY-Series .....	28
GEHNY-Series .....	29
GFHNY-Series .....	30
PSH-Series .....	31
GGPTFE-Series .....	32
EPTFE-Series .....	33
BRPTFE-Series .....	34
PPTFE-Series .....	35
GPFA-Series .....	36

<b>High Flow Cartridges .....</b>	<b>38</b>
HFB-Series .....	39
EHF3-Series .....	40
HF/HF3-Series .....	41
<b>Depth Cartridges .....</b>	<b>42</b>
GPB-Series .....	43
GWTB-Series .....	44
GWTB BB-Series .....	45
GCTB-Series .....	46
GATB-Series .....	47
GRU-V-Series .....	48
G-Series-Wound .....	49
<b>Liquid Filter Bags .....</b>	<b>50</b>
Standard Felt .....	51
Standard Mesh .....	52
High Efficiency .....	53
<b>Filter Vessels .....</b>	<b>54</b>
GFHD-Series .....	55
GTCHB-Series .....	56
GTCH-Series .....	57
GBFE4-Series .....	58
GBFV8-Series Stainless Steel & Carbon Steel .....	59
GBFV82-Series Twin Capacity Stainless Steel .....	60
GMBV-Series .....	61
GMBE-Series Stainless & Carbon Steel .....	62



# GLOBAL FILTER IS PART OF FILTRATION GROUP



A global leader in process filtration, Global Filter delivers the performance, quality and consistency you need to separate you from your competition. Our strong heritage is reflected in our brand and our record of accomplishments. Global Filter is an industry leader and innovator with a continuing commitment towards technological expertise and service. With extensive market expertise that includes the **food & beverage**, **pharmaceuticals**, **industrial**, **microelectronics**, and **energy industries**, we have all your processing needs covered.

**Food & Beverage** – We are proud to be recognized as a premier supplier of depth, pleated depth, pleated membrane cartridges and filter vessels for the **food & beverage** industry.

**Pharmaceuticals** – We promise high purity, efficiency, and economy to our customers. Our products undergo demanding integrity tests and are certified in our hygienic production facilities.

**Microelectronics** – We provide superior filtration solutions for high purity manufacturing and processing of semiconductor components and products.

**Industrial** – Our filtration products and services are utilized by customers in a wide variety of industries including: **paints, inks & coatings, water treatment, mining & minerals, chemicals**.

**Trusted OEM Partner** – We work with OEMs to help improve equipment performance, reduce development time and enhance after-market service and support. Through our global footprint, we strengthen your ability to provide after-market service and technical support to end-user customers.



## FILTRATION GROUP GLOBAL FOOTPRINT

With world-class engineering and manufacturing capabilities.

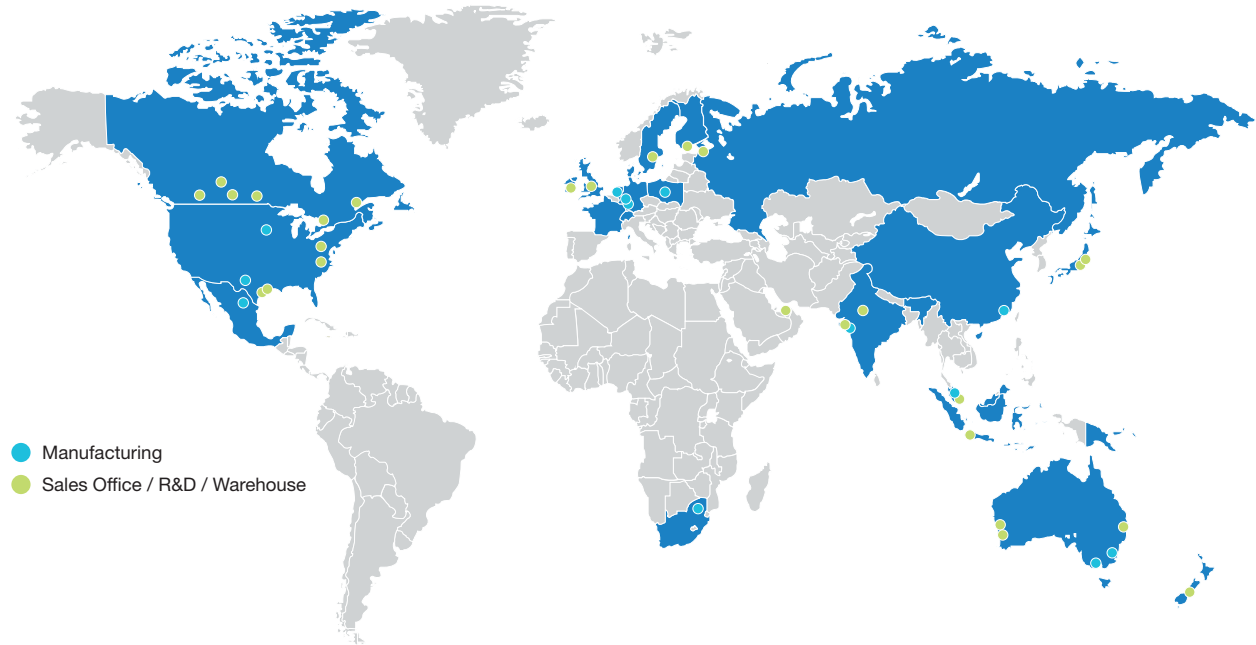

## FOUNDED IN 1999



Founded in 1999 in Cedar Rapids, Iowa, **Global Filter** produces high-purity pleated filter cartridges in our advanced technology production facility. From modest beginnings as a family, home-based business, today Global Filter serves customers, as our name implies, around the globe. Some of the largest companies in the world trust their filtration requirements to Global Filter.

At Global Filter, we continually strive to improve the quality of our products as well as the processes that develop and manufacture them. We have steadily increased our total footprint of cleanroom-level environment for the production, rinsing, and testing of our high-purity offerings. These improvements have resulted in increased capacity and shortened lead times while enhancing the cleanliness of our rinsed products and our entire range of filter elements.

Advancement of our technological capabilities is a pillar of Global Filter's business and we're proud of our reputation as a leader in tackling difficult challenges. Our engineers and technicians work closely with customers to identify specific filtration needs and provide development support for major filtration projects, while being attentive to objectives for product cost and schedule. We support our programs with capable testing services to provide world-class best net value.

Our commitment to excellence in cleanliness, efficiency, quality, and service is driven by our goal to exceed the requirements of our customers. Our goal is complete customer satisfaction and it is reflected in everything we do.

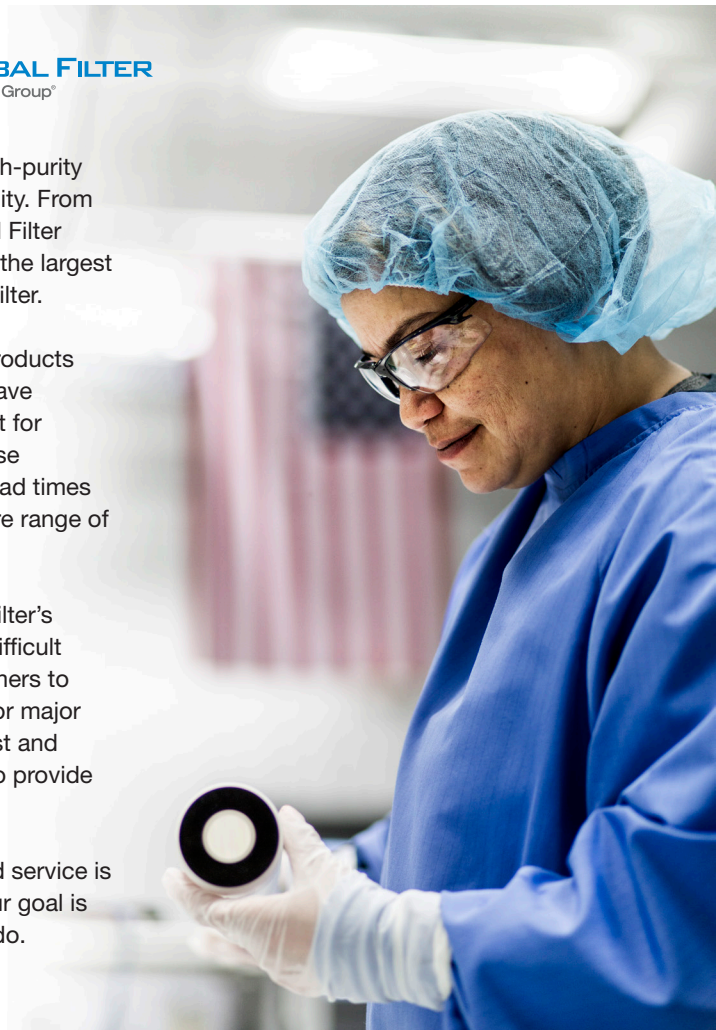



# WE PROVIDE FILTRATION SOLUTIONS FOR A WIDE RANGE OF INDUSTRIES:



## Food & Beverage

We are proud to be recognized as a premier supplier of depth, pleated depth, pleated membrane cartridges and vessels for the Food & Beverage industry.

- Bottled Water
- Dairy
- Cider
- Distilled Spirits
- Food Ingredients
- Juices & Soft Drinks
- Sugar & Corn Syrup
- Wine
- Beer
- Flavorings



## Life Sciences

We promise high purity, efficiency, and economy to our customers. Our products are stringently tested and certified in our hygienic production facilities.

- Clarification & Pre-filtration
- Bioburden Reduction & Sterilization
- Venting and Gas Filtration
- Ultrapure Water & Utilities



## Paints, Inks & Coatings

Improving your products' quality and your bottom line is why we do what we do. Filtration solutions that help you achieve your goals.

- Stains & Lacquers
- High Purity Paints
- Inkjet Inks
- Automotive Paints
- Laser Inks
- Clear Coats



## Chemicals

We understand the impact improper filtration can have on the chemical products you produce and the overall adverse impact that can have on your business.

- Bleach
- Resins & Adhesives
- Dyestuffs
- Hydrogen Peroxide
- Intermediates
- Raw Materials
- Buffer Solutions
- Cosmetics



## Microelectronics

Providing superior filtration solutions for the high purity manufacture and processing of semiconductor components and products.

- Ultrapure Chemicals
- Ultrapure Water
- Ultrapure Air & Gases



## Water Treatment

We understand the importance as well as impact of water in our everyday lives and the intricacies of producing it.

- Process Water
- R.O. Pre-filtration
- Ultrapure Water
- Municipal Water
- Waste Water
- Injection Water

OUR PRODUCTS

---

# VESSELS IN STOCK, READY TO SHIP

---

Improve cleanliness and optimize your processes with our full line of filtration products:

- Pleated Depth & Membrane Cartridges
- Depth Cartridges
- Swing-Bolt Cartridge & Bag Vessels
- Band-Clamp Cartridge & Bag Vessels

## Cartridge End Cap Configurations



**Open (DOE)**

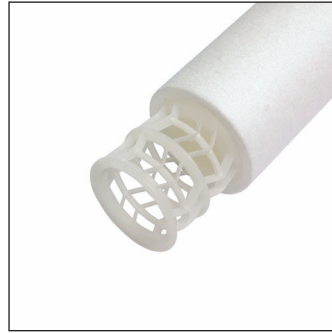

**Spring**



**PP Core Extender**



**213 Internal O-Ring**



**Flat (for 213)**



**222**



**222 (w/SS Insert)**



**226**



**226 (w/SS Insert)**



**Flat Cap**



**Fin**



**222 3-tab**

DS\_ENDCAPS\_190819

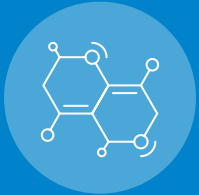

## PLEATED CARTRIDGES

Our multi-layer, fiber-based medias provide true depth-loading for high efficiency removal at low micron ratings. Pleated design increases surface area which in turn, increases loading capacity and allows for higher flow rates.



## PP-Series High Purity Pleated Polypropylene

PP-Series High Purity Pleated Polypropylene Filter Cartridges provide a high area, 100% polypropylene element for removal of fine or coarse particulate from fluid streams.

The pleated depth media is encapsulated in an integral, continuous length, thermally-bonded structure for cleanliness, pressure tolerance, and chemical inertness. Offered in both absolute-rated (up to 99.98% retention) and nominally-rated (90% retention) grades in all end configurations. Manufactured in a clean-room environment to maintain high standards of purity and cleanliness.

Commonly used in food/beverage and chemical applications as a final filter or prefiltration stage.

### Flow Rate vs Pressure Drop

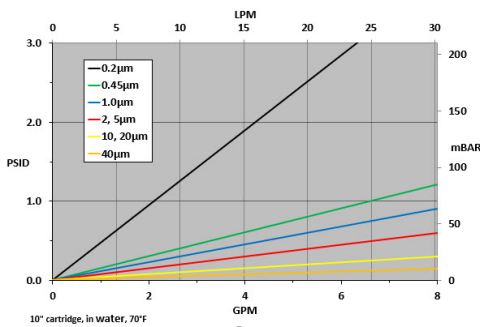

\*All data is based on absolute rated medias. Nominally rated medias will result in a pressure drop reduction of approximately 10%.

### Typical Applications

- Food & Beverage
- Deionized Water
- R.O. Pre-Filtration
- Process Water
- Fine Chemicals
- Plating Chemicals
- Wastewater
- Pharmaceutical Prefiltration



### Construction Materials

**Filtration Media**..... Polypropylene  
**Support Media**..... Polypropylene  
**End Caps**..... Polypropylene  
**Center Core**..... Polypropylene  
**Outer Support Cage**..... Polypropylene  
**O-Rings/Gaskets**..... Buna, EPDM, Silicone, Teflon® Encapsulated Viton®, Viton®, Teflon® Encapsulated Silicone

### Sanitization/Sterilization

**Filtered Hot Water**.....80°C for 30 min.  
**Steam Sterilization**.....121°C for 30 min., multiple cycles

**Chemicals:** Cartridges are compatible with most chemical sanitizing agents.

**Note:** Stainless steel insert option required for all cartridges being hot water sanitized or steam sterilized.



NSF Certification applies for use only with drinking water. Only products bearing the NSF Mark on the product, product packaging, and/or documentation shipped with the product are Certified. Product options denoted with asterisk (\*) are not included in the Certification.

### Dimensions

**Length:**  
10 to 40 inches (25.4 to 101.6 cm) nominal  
**Outside Diameter:**  
2.70 inches (7.0 cm) nominal

### Operating Conditions

**Change Out ΔP (recommended)**.....35 PSID  
**Temperature (max)**.....176°F (80°C)  
**Differential Pressure (max)**.....60 PSID (4.1 bar) at 68°F (20°C)

### Toxicity

All polypropylene components meet the specifications for biological safety per USP Class VI – 121°C for plastics.

### Food Safety Compliance

Materials of construction comply with FDA regulations for food and beverage contact use as detailed in the US Code of Federal Regulations, 21CFR. Materials used to produce filter media and hardware are deemed safe for use in contact with foodstuffs in accordance with EU Directives 2002/72/EC, 1935/2004, and/or 10/2011.

### Ordering Information

PP	Rating (µ)	Retention	Length	C	End Cap Style	O-Rings/Gaskets	-	Adders
	0.2	A = Absolute	10" (25.4 cm)		2 = DOE Flat Gasket	B = Buna		CS = 316SS Compression Spring
	0.45	N = Nominal	20" (50.8 cm)		3 = 222 w/ Fin	E = EPDM		FG = Glass Reinforced PP Core *
	1.0		30" (76.2 cm)		4 = 222 w/ Flat Cap	S = Silicone		HP = Heavy Poly Core *
	2.0		40" (101.6 cm)		5 = 222 w/ Spring	T = Teflon® Encapsulated Viton®*		I = Stainless Steel Insert
	5.0				6 = 226 w/ Flat Cap	V = Viton®*		R = 18 Megaohm Rinse
	10.0				7 = 226 w/ Fin	Z = Teflon® Encapsulated Silicone *		SS = Stainless Steel Core
	20.0				8 = 226 w/ Spring			
	40.0				16 = 213 Internal O-Ring			
					28 = 222 3-tabs w/ Fin			

DISCLAIMER: Filtration data presented is representative of performance observed in controlled laboratory testing. It is not given as a warranty, specification or statement of fitness for use. Specific performance can vary widely depending on contaminant type, fluid properties, flow rates and environmental conditions. It is recommended that users conduct thorough qualification testing to assure the product functions as required. For additional technical support, a product Performance Guide is available upon request.

DS\_PP\_190918



## PPE-Series Economy Grade Pleated Polypropylene

PPE-Series High Purity Economy Grade Pleated Polypropylene Filter Cartridges provide an economical, 100% polypropylene element for removal of fine or coarse particulate from fluid streams.

The pleated depth media is encapsulated in an integral, continuous length, thermally-bonded structure for cleanliness, pressure tolerance, and chemical inertness. Offered in both absolute rated (up to 99.98% retention) and nominally rated (90% retention) grades in common adapter configurations. Manufactured in a clean-room environment to maintain high standards of purity and cleanliness.

### Flow Rate vs Pressure Drop

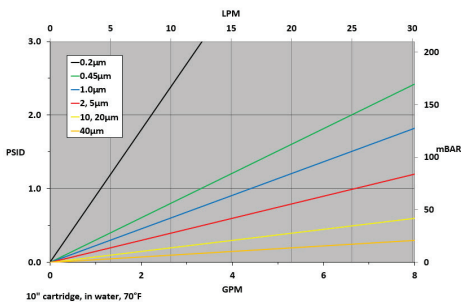

\*All data is based on absolute rated medias. Nominally rated medias will result in a pressure drop reduction of approximately 10%.

### Typical Applications

- Food & Beverage
- Deionized Water
- R.O. Pre-Filtration
- Process Water
- Fine Chemicals
- Plating Chemicals
- Wastewater
- Pharmaceuticals



### Construction Materials

**Filtration Media**..... Polypropylene  
**Support Media**..... Polypropylene  
**End Caps**..... Polypropylene  
**Center Core**..... Polypropylene  
**Outer Support Cage**..... Polypropylene  
**O-Rings/Gaskets**..... Buna, EPDM, Silicone, Teflon® Encapsulated Viton®, Viton®

### Toxicity

All polypropylene components meet the specifications for biological safety per USP Class VI – 121°C for plastics.



Certified to NSF/ANSI/CAN 61

NSF Certification applies for use only with drinking water. Only products bearing the NSF Mark on the product, product packaging, and/or documentation shipped with the product are Certified. Product options denoted with asterisk (\*) are not included in the Certification.

### Dimensions

**Length:**  
10 to 40 inches (25.4 to 101.6 cm) nominal  
**Outside Diameter:**  
2.50 inches (6.35 cm) nominal

### Operating Conditions

**Change Out ΔP (recommended)**.....35 PSID  
**Temperature (max)**.....176°F (80°C)  
**Differential Pressure (max)**.....60 PSID (4.1 bar) at 68°F (20°C)

### Food Safety Compliance

Materials of construction comply with FDA regulations for food and beverage contact use as detailed in the US Code of Federal Regulations, 21CFR. Materials used to produce filter media and hardware are deemed safe for use in contact with foodstuffs in accordance with EU Directives 2002/72/EC, 1935/2004, and/or 10/2011.

### Ordering Information

PPE	Rating (µ)	Retention	Length	C	End Cap Style	O-Rings/Gaskets	-	Adders
	0.2	A = Absolute	10" (25.4 cm)		2 = DOE Flat Gasket	B = Buna		CS = 316SS Compression Spring
	0.45	N = Nominal	20" (50.8 cm)		3 = 222 w/ Fin	E = EPDM		I = Stainless Steel Insert
	1.0		30" (76.2 cm)		4 = 222 w/ Flat Cap	S = Silicone		SS = Stainless Steel Core
	2.0		40" (101.6 cm)		5 = 222 w/ Spring	T = Teflon® Encapsulated Viton®*		
	5.0					V = Viton®*		
	10.0							
	20.0							
	40.0							

DISCLAIMER: Filtration data presented is representative of performance observed in controlled laboratory testing. It is not given as a warranty, specification or statement of fitness for use. Specific performance can vary widely depending on contaminant type, fluid properties, flow rates and environmental conditions. It is recommended that users conduct thorough qualification testing to assure the product functions as required. For additional technical support, a product Performance Guide is available upon request.

DS\_PPE\_190918

## FG-Series Pleated Microglass Media

FG-Series High Purity Pleated Borosilicate Microglass Filter Cartridges offer high-efficiency retention of particulate matter from liquid and gaseous fluid streams. Favored for its superior retention efficiency, low pressure drop, and greater contaminant loading capacity relative to alternative medias. Suitable for food and potable water contact, the FG-Series delivers to the high performance demands in food production and bottled water. Also has broad use with process water, lubricants, and a range of fine chemicals. Manufactured in a clean-room environment to maintain high standards of purity and cleanliness.

Offered in both absolute-rated (up to 99.98% retention) and nominally-rated (90% retention) grades in common adapter configurations.

### Flow Rate vs Pressure Drop

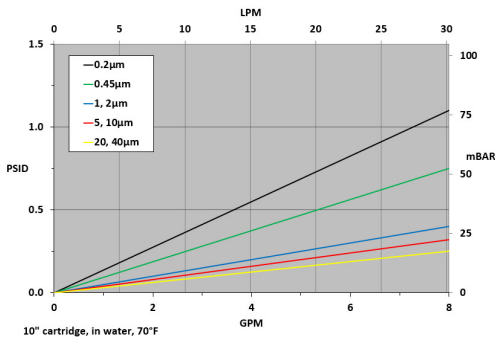

\*All data is based on absolute rated medias. Nominally rated medias will result in a pressure drop reduction of approximately 10%.

### Typical Applications

- Food & Beverage
- Deionized Water
- Process Water
- Fine Chemicals
- Wastewater
- Produced Water
- Wine Clarification
- Sweeteners

### Ordering Information

FG	Rating (μ)	Retention	Length	C	End Cap Style	O-Rings/Gaskets	-	Adders
	0.2	A = Absolute	10" (25.4 cm)		2 = DOE Flat Gasket	B = Buna		CS = 316SS Compression Spring
	0.45	N = Nominal	20" (50.8 cm)		3 = 222 w/ Fin	E = EPDM		I = Stainless Steel Insert
	1.0		30" (76.2 cm)		4 = 222 w/ Flat Cap	S = Silicone		R = 18 Megaohn Rinse
	2.0		40" (101.6 cm)		5 = 222 w/ Spring	T = Teflon® Encapsulated Viton®		SS = Stainless Steel Core
	5.0				6 = 226 w/ Flat Cap	V = Viton®		
	10.0				7 = 226 w/ Fin	Z = Teflon® Encapsulated Silicone		
	20.0				8 = 226 w/ Spring			
	40.0				16 = 213 Internal O-Ring			
					28 = 222 3-tabs w/ Fin			

DISCLAIMER: Filtration data presented is representative of performance observed in controlled laboratory testing. It is not given as a warranty, specification or statement of fitness for use. Specific performance can vary widely depending on contaminant type, fluid properties, flow rates and environmental conditions. It is recommended that users conduct thorough qualification testing to assure the product functions as required. For additional technical support, a product Performance Guide is available upon request.

DS\_FG\_190918



### Construction Materials

**Filtration Media**.....Borosilicate microglass with acrylic binder.  
**Support Media**.....Spun-bonded polyester  
**End Caps**.....Polypropylene  
**Center Core**.....Glass-reinforced Polypropylene  
**Outer Support Cage**.....Polypropylene  
**O-Rings/Gaskets**.....Buna, EPDM, Silicone, Teflon® Encapsulated Viton®, Viton®, Teflon®, Encapsulated Silicone

### Sanitization/Sterilization

**Filtered Hot Water**.....80°C for 30 min.  
**Steam Sterilization**.....121°C for 30 min., multiple cycles

**Chemicals:** Cartridges are compatible with most chemical sanitizing agents.

**Note:** Stainless steel end cap insert option required for all cartridges being hot water sanitized or steam sterilized.

### Toxicity

All polypropylene components meet the specifications for biological safety per USP Class VI – 121°C for plastics.

### Dimensions

**Length:** 10 to 40 inches (25.4 to 101.6 cm) nominal  
**Outside Diameter:** 2.75 inches (7.0 cm) nominal

### Operating Conditions

**Change Out ΔP (recommended)**.....35 PSID  
**Temperature (max)**.....176°F (80°C)  
**Differential Pressure (max)**.....60 PSID (4.1 bar) at 68°F (20°C)

**Note:** Optional high temperature construction available featuring stainless steel core (235°F).

### Food Safety Compliance

Materials of construction comply with FDA regulations for food and beverage contact use as detailed in the US Code of Federal Regulations, 21CFR. Materials used to produce filter media and hardware are deemed safe for use in contact with foodstuffs in accordance with EU Directives

## FGE-Series Economy Grade Pleated Microglass Media

FGE-Series High Purity Economy Grade Pleated Borosilicate Microglass Filter Cartridges offer high-efficiency retention of particulate matter from liquid and gaseous fluid streams. Favored for its superior retention efficiency, low pressure drop, and greater contaminant loading capacity relative to alternative medias. The FGE-Series is often the preferred choice when the application calls for a more economical option or where the 2.5" OD is required. Also, the polyester hardware construction allows extended temperature use (up to 200°F).

Suitable for food and potable water contact, the FGE-Series meets the high performance demands in food and beverage production. Also suitable for use in a broad range of applications, including process water, lubricants, and a range of fine chemicals. Manufactured in a clean-room environment to maintain high standards of purity and cleanliness.

Offered in both absolute-rated (up to 99.98% retention) and nominally-rated (90% retention) grades in common adapter configurations.

### Flow Rate vs Pressure Drop

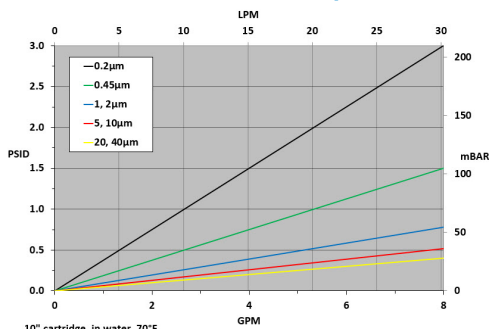

\*All data is based on absolute rated medias. Nominally rated medias will result in a pressure drop reduction of approximately 10%.



### Typical Applications

- Food & Beverage
- Deionized Water
- Process Water
- Fine Chemicals
- R.O. Pre-Filtration
- Wastewater
- Produced Water
- Wine Clarification
- Sweeteners

### Construction Materials

**Filtration Media**.....Borosilicate Microglass with acrylic binder  
**Support Media**.....Spun-bonded Polyester  
**End Caps**.....Polyester  
**Center Core**.....Glass-filled Polypropylene  
**Outer Support Netting**.....Polyester  
**O-Rings/Gaskets**...Buna, EPDM, Silicone, Teflon® Encapsulated Viton®, Viton®

### Dimensions

**Length:**  
10 to 40 inches (25.4 to 101.6 cm) nominal  
**Outside Diameter:**  
2.50 inches (6.35 cm) nominal

### Operating Conditions

**Change Out ΔP (recommended)**.....35 PSID  
**Temperature (max)**.....200°F (93°C)  
**Differential Pressure (max)**.....60 PSID (4.1 bar) at 68°F (20°C)

**Note:** Optional high temperature construction available featuring stainless steel core (235°F).

### Food Safety Compliance

Materials of construction comply with FDA regulations for food and beverage contact use as detailed in the US Code of Federal Regulations, 21CFR. Materials used to produce filter media and hardware are deemed safe for use in contact with foodstuffs in accordance with EU Directives 2002/72/EC, 1935/2004, and/or 10/2011.

### Ordering Information

FGE	Rating (µ)	Retention	Length	N	End Cap Style	O-Rings/Gaskets	-	Adders
	0.2	A = Absolute	10" (25.4 cm)		2 = DOE Flat Gasket	B = Buna		CS = 316SS Compression Spring
	0.45	N = Nominal	20" (50.8 cm)		3 = 222 w/ Fin	E = EPDM		I = Stainless Steel Insert
	1.0		30" (76.2 cm)		4 = 222 w/ Flat Cap	S = Silicone		SS = Stainless Steel Core
	2.0		40" (101.6 cm)		5 = 222 w/ Spring	T = Teflon® Encapsulated Viton®		
	5.0					V = Viton®		
	10.0							
	20.0							
	40.0							

DISCLAIMER: Filtration data presented is representative of performance observed in controlled laboratory testing. It is not given as a warranty, specification or statement of fitness for use. Specific performance can vary widely depending on contaminant type, fluid properties, flow rates and environmental conditions. It is recommended that users conduct thorough qualification testing to assure the product functions as required. For additional technical support, a product Performance Guide is available upon request.

DS\_FGE\_190918

## PEE-Series Economy Grade Pleated Polyester Depth Media

PEE-Series Economy Grade Pleated Polyester Depth Media Filter Cartridges offer an efficient and economical filtration option with broad application. The all-polyester construction allows higher temperature use (up to 235°F). The 2.5" OD allows use in housings where larger cartridges do not fit. Manufactured in a clean-room environment to maintain high standards of purity and cleanliness.

Offered in both absolute-rated (up to 99.98% retention) and nominally-rated (90% retention) grades in common adapter configurations and seal material types.

### Flow Rate vs Pressure Drop

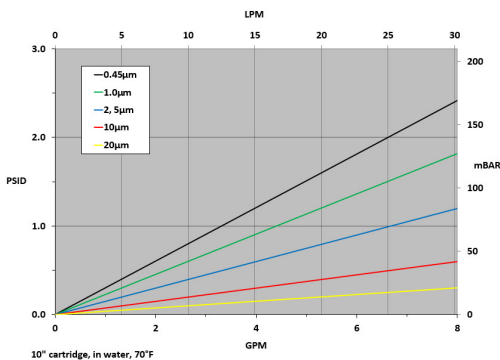

\*All data is based on absolute rated medias. Nominally rated medias will result in a pressure drop reduction of approximately 10%.



### Typical Applications

- Process Water
- Solvents
- Fine Chemicals
- Plating Chemicals
- Wastewater
- Produced Water
- Hydrocarbons
- Synthetic Lubricants

### Construction Materials

**Filtration Media**.....Pleated Polyester Meltblown  
**Support Media**.....Spun-bonded Polyester  
**End Caps**.....Polyester  
**Center Core**.....Polyester  
**Outer Support Netting**.....Polyester  
**O-Rings/Gaskets**.....Buna, EPDM, Silicone, Viton®, Teflon® Encapsulated Viton®

### Dimensions

**Length:**  
 10 to 40 inches (25.4 to 101.6 cm) nominal  
**Outside Diameter:**  
 2.50 inches (6.35 cm) nominal

### Operating Conditions

**Change Out ΔP (recommended)**.....35 PSID  
**Temperature (max)**.....235°F (113°C)  
**Differential Pressure (max)**.....60 PSID  
 (4.1 bar) at 68°F (20°C)

### Ordering Information

PEE	Rating (µ)	Retention	Length	N	End Cap Style	O-Rings/Gaskets	-	Adders
	0.45	A = Absolute	10" (25.4 cm)		2 = DOE Flat Gasket	B = Buna		CS = 316SS Compression Spring
	1.0	N = Nominal	20" (50.8 cm)		3 = 222 w/ Fin	E = EPDM		SS = Stainless Steel Core
	2.0		30" (76.2 cm)		4 = 222 w/ Flat Cap	S = Silicone		
	5.0		40" (101.6 cm)		5 = 222 w/ Spring	T = Teflon® Encapsulated Viton®		
	10.0					V = Viton®		
	20.0							

DISCLAIMER: Filtration data presented is representative of performance observed in controlled laboratory testing. It is not given as a warranty, specification or statement of fitness for use. Specific performance can vary widely depending on contaminant type, fluid properties, flow rates and environmental conditions. It is recommended that users conduct thorough qualification testing to assure the product functions as required.

DS\_PEE\_190918



## LiquidClear™ GF-Series Pleated Synthetic Depth Media

LiquidClear GF-Series Pleated Synthetic Depth Media Filter Cartridges offer economical, cellulose-free construction with significant dirt-holding capacity and low pressure drop at nominal efficiencies. Generally provides better performance value relative to string-wound, meltblown, and resin-bonded alternatives. PVC plastisol end caps offer an integral and positive seal.

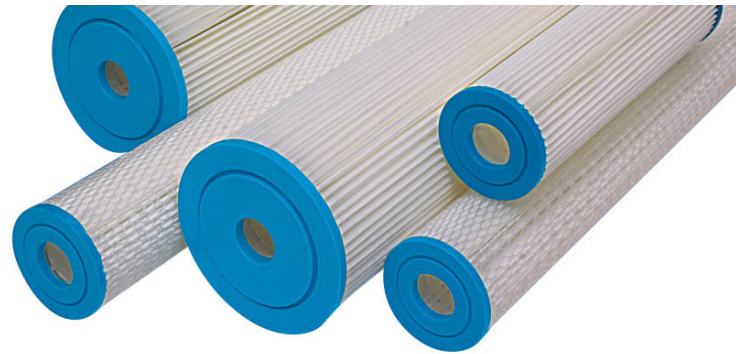

### Flow Rate vs Pressure Drop

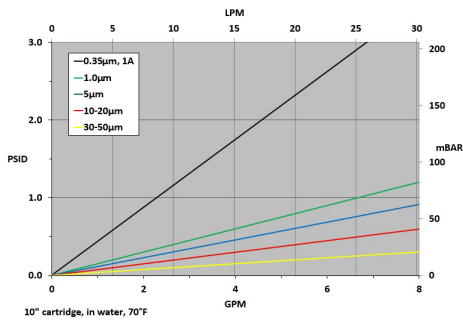

\*For 4.5" OD-sized elements, the differential pressure is 30% that of the values shown above for 2.7" OD cartridges.

### Operating Conditions

**Change Out ΔP (recommended)**.....20-25 PSID  
**Temperature (max)**.....140°F (60°C)  
**Differential Pressure (max)**.....50 PSID  
 (3.4 bar) at 68°F (20°C)

### Typical Applications

- Process Water
- Cooling Water
- Drinking Water
- R.O. Pre-Filtration
- Plating Chemicals
- Food & Beverage
- Wastewater
- Deionized Water

### Dimensions

**Outside Diameter**..... 2.7 or 4.5 inch  
**Inside Diameter**.....1 inch  
**Lengths**.....9.75 to 40 inch

### Purity

LiquidClear cartridges are produced using 100% synthetic fibers, which are free of binders or adhesives.

### Construction Materials

**Filtration Media**.....Polypropylene, Polyester  
**End Caps/Gasket**..... Polyurethane  
**Core**.....Polypropylene  
**Outer Netting**..... Polypropylene

### Cross-Reference

**Pentek®**..... R-Series, ECP-Series  
**Watts®**..... FM-Series

### Performance Specifications

**Micron Ratings**.....0.35,1,1A,5,10,20,30,50  
**Efficiencies**..... 0.35-50μ = Nominal  
 1A = 99%

### Food Safety Compliance

Materials of construction comply with FDA regulations for food and beverage contact use as detailed in the US Code of Federal Regulations, 21CFR. Materials used to produce filter media and hardware are deemed safe for use in contact with foodstuffs in accordance with EU Directives 2002/72/EC, 1935/2004, and/or 10/2011.

### Ordering Information

GF	-	Diameter	-	Rating (μ)	-	Length	End Cap Style
		Blank = 2.7		0.35		9.75"	Blank = DOE
		BB = 4.5		1		10" (BB Only)	
				1A		19.5"	
				5		20"	
				10		29.25"	
				20		30"	
				30		40"	
				50			

DISCLAIMER: Filtration data presented is representative of performance observed in controlled laboratory testing. It is not given as a warranty, specification or statement of fitness for use. Specific performance can vary widely depending on contaminant type, fluid properties, flow rates and environmental conditions. It is recommended that users conduct thorough qualification testing to assure the product functions as required.

DS\_GF\_200217



## GFH-Series All-Halar® Fluoropolymer Depth Media

GFH-Series High Purity All-Halar Fluoropolymer Depth Media Filter Cartridges are ideal for filtration of aggressive solvents, acids, and caustics. Constructed of 100% ECTFE Halar for superior chemical tolerance in demanding industrial applications. The meltblown microfiber media provides excellent flow at low pressure drop and greater contaminant holding capacity relative to membrane-based options. The >90% typical retention efficiency allows for use as either a pre-filter or final filtration solution.



### Flow Rate vs Pressure Drop

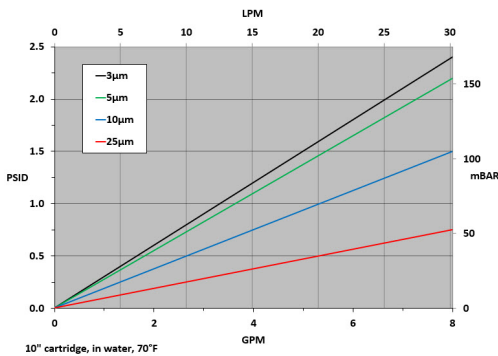

### Typical Applications

- Toluene
- Xylene
- Ozonated Process Systems or Water
- Bulk Chemical Polishing

### Construction Materials

Media .....ECTFE  
 Support Media .....ECTFE  
 End Caps .....ECTFE  
 Center Core .....ECTFE  
 Outer Support Cage .....ECTFE  
 O-Rings/Gaskets .....Teflon®  
 Encapsulated Viton®, Viton®

### Sanitization/Sterilization

GFH cartridges may be sanitized using compatible chemical agents. GFH cartridges may not be autoclaved or steam sterilized.

### Dimensions

**Length:**  
 10 to 40 inches (25.4 to 101.6 cm) nominal  
**Outside Diameter:**  
 2.70 inches (7.0 cm) nominal

### Operating Conditions

**Change Out ΔP (recommended)** .....35 PSID  
**Temperature (max)** .....190°F (88°C)  
**Differential Pressure (max)** .....60 PSID  
 (4.1 bar) at 68°F (20°C)

### Toxicity

All components meet the specifications for biological safety per USP Class VI – 121°C for plastics.

### Food Safety Compliance

Materials of construction comply with FDA regulations for food and beverage contact use as detailed in the US Code of Federal Regulations, 21CFR. Materials used to produce filter media and hardware are deemed safe for use in contact with foodstuffs in accordance with EU Directives 2002/72/EC, 1935/2004, and/or 10/2011.

### Ordering Information

GFH	Rating (µ)	A	Length	C	End Cap Style	O-Rings/Gaskets
	3.0		10" (25.4 cm)		2 = DOE Flat Gasket	T = Teflon® Encapsulated Viton®
	5.0		20" (50.8 cm)		3 = 222 w/ Fin	V = Viton®
	10.0		30" (76.2 cm)		4 = 222 w/ Flat Cap	
	25.0		40" (101.6 cm)		6 = 226 w/ Flat Cap	
					7 = 226 w/ Fin	

DISCLAIMER: Filtration data presented is representative of performance observed in controlled laboratory testing. It is not given as a warranty, specification or statement of fitness for use. Specific performance can vary widely depending on contaminant type, fluid properties, flow rates and environmental conditions. It is recommended that users conduct thorough qualification testing to assure the product functions as required.

DS\_GFH\_190918



## PLEATED MEMBRANE CARTRIDGES

Pleated Membrane cartridges remove particulate and microbial contaminants. Multiple media and grade options available to optimize performance, even in the most demanding applications.

## GHPS-Series Polysulfone

GHPS-Series High Purity Polysulfone Filter Cartridges offer exceptional flowrate and loading capability by virtue of its highly asymmetrical pore structure. It's a preferred choice in applications requiring the efficiency of a membrane but where a longer service life is important. Its hydrophilic nature allows immediate wet-out and optimizes the utility of the membrane surface area. Manufactured in a high-purity, thermally-bonded construction for cleanliness and broad compatibility, the optional post-rinse feature provides a cartridge with quick rinse-up to 18 megaohms. Manufactured in a clean-room environment to maintain high standards of purity and cleanliness.



### Flow Rate vs Pressure Drop

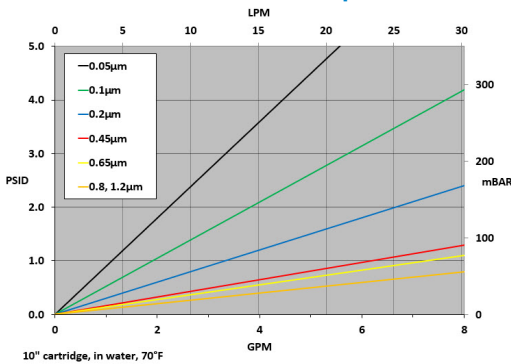

### Typical Applications

- Deionized Water Systems
- General-Use Water Filtration
- Liquid Clarification
- Recirculating Fluids
- Chemical Filtration

### Construction Materials

**Membrane**.....Polysulfone  
**Support Media**.....Polypropylene  
**End Caps**.....Polypropylene  
**Center Core**.....Polypropylene  
**Outer Support Cage**.....Polypropylene  
**O-Rings/Gaskets**.....Buna, EPDM, Silicone,  
 Teflon® Encapsulated Viton®, Viton®,  
 Teflon® Encapsulated Silicone

### Sanitization/Sterilization

**Filter Hot Water**.....80°C for 30 min  
**Steam Sterilization**.....121°C for 30 min.,  
 multiple cycles

**Chemicals:** Cartridges are compatible with most chemical sanitizing agents.

**Note:** Stainless steel insert option required for all cartridges being hot water sanitized or steam sterilized.

### Toxicity

All polypropylene components meet the specifications for biological safety per USP Class VI – 121°C for plastics.

### Dimensions

**Length:**  
 10 to 40 inches (25.4 to 101.6 cm) nominal  
**Outside Diameter:**  
 2.70 inches (7.0 cm) nominal

### Operating Conditions

**Change Out ΔP (recommended)**.....35 PSID  
**Temperature (max)**.....176°F (80°C)  
**Differential Pressure (max)**.....50 PSID  
 (3.4 bar) at 68°F (20°C)

### Food Safety Compliance

Materials of construction comply with FDA regulations for food and beverage contact use as detailed in the US Code of Federal Regulations, 21CFR. Materials used to produce filter media and hardware are deemed safe for use in contact with foodstuffs in accordance with EU Directives 2002/72/EC, 1935/2004, and/or 10/2011.

### Ordering Information

GHPS	Rating (µ)	A	Length	C	End Cap Style	O-Rings/Gaskets	-	Adders
	0.05		10" (25.4 cm)		2 = DOE Flat Gasket	B = Buna		CS = 316SS Compression Spring
	0.1		20" (50.8 cm)		3 = 222 w/ Fin	E = EPDM		HP = Heavy Poly Core
	0.2		30" (76.2 cm)		4 = 222 w/ Flat Cap	S = Silicone		I = Stainless Steel Insert
	0.45		40" (101.6 cm)		6 = 226 w/ Flat Cap	T = Teflon® Encapsulated Viton®		R = 18 Megaohm Rinse
	0.65				7 = 226 w/ Fin	V = Viton®		
	0.8				16 = 213 Internal O-Ring	Z = Teflon® Encapsulated Silicone		
	1.2				28 = 222 3-tabs w/ Fin			

DISCLAIMER: Filtration data presented is representative of performance observed in controlled laboratory testing. It is not given as a warranty, specification or statement of fitness for use. Specific performance can vary widely depending on contaminant type, fluid properties, flow rates and environmental conditions. It is recommended that users conduct thorough qualification testing to assure the product functions as required.

DS\_GHPS\_190918

## GW PES-Series Water Service Grade Polyethersulfone

GW PES-Series High Purity Water Service Grade Polyethersulfone Filter Cartridges are a value-oriented, reduced surface area choice for cost effective, general purpose membrane filtration. The highly retentive polyethersulfone membrane offers excellent flux density and low protein-binding. The naturally hydrophilic membrane wets easily to allow for the maximum utilization of the surface area. These features allow the GW PES-Series to provide the fine performance of PES membrane at a competitive price. Manufactured in a clean-room environment to maintain high standards of purity and cleanliness. Designed to tolerate repeated hot water sanitization and in-situ steam sterilization cycles.

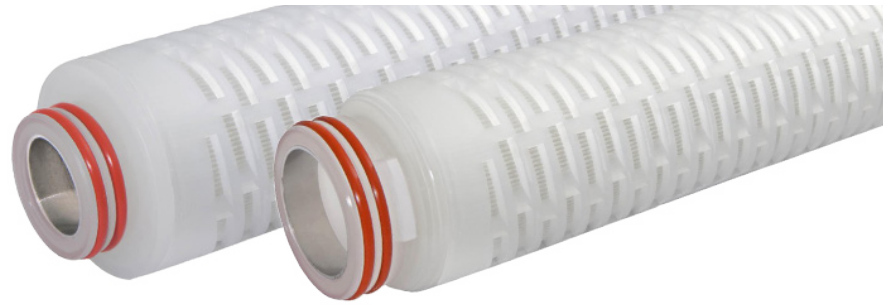

### Flow Rate vs Pressure Drop

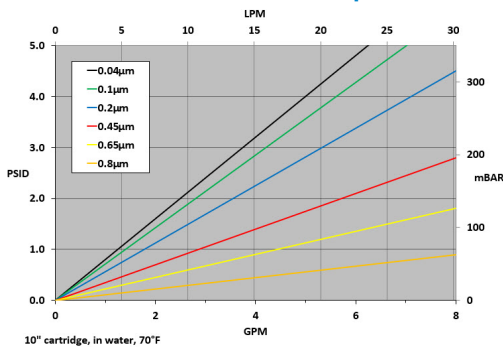

### Typical Applications

- Deionized Water Systems
- General-Use Water Filtration
- Liquid Clarification
- Recirculating Fluids
- Chemical Filtration

### Construction Materials

**Membrane**..... Polyethersulfone  
**Support Media**..... Polypropylene  
**End Caps**..... Polypropylene  
**Center Core**..... Polypropylene  
**Outer Support Cage**..... Polypropylene  
**O-Rings/Gaskets**..... Buna, EPDM, Silicone, Teflon® Encapsulated Viton®, Viton®, Teflon® Encapsulated Silicone

### Sanitization/Sterilization

**Filtered Hot Water**..... 80°C for 30 min.  
**Steam Sterilization**..... 121°C for 30 min., multiple cycles

**Chemicals:** Cartridges are compatible with most chemical sanitizing agents.

**Note:** Stainless steel insert required for all cartridges being hot water sanitized or steam sterilized.

### Toxicity

All polypropylene components meet the specifications for biological safety per USP Class VI – 121°C for plastics.

### Dimensions

**Length:** 10 to 40 inches (25.4 to 101.6 cm) nominal  
**Outside Diameter:** 2.70 inches (7.0 cm) nominal

### Operating Conditions

**Change Out ΔP (recommended)**..... 35 PSID  
**Temperature (max)**..... 176°F (80°C)  
**Differential Pressure (max)**..... 50 PSID (3.4 bar) at 68°F (20°C)

### Food Safety Compliance

Materials of construction comply with FDA regulations for food and beverage contact use as detailed in the US Code of Federal Regulations, 21CFR. Materials used to produce filter media and hardware are deemed safe for use in contact with foodstuffs in accordance with EU Directives 2002/72/EC, 1935/2004, and/or 10/2011.

### Ordering Information

GW PES	Rating (µ)	A	Length	C	End Cap Style	O-Rings/Gaskets	-	Adders
	0.04		10" (25.4 cm)		2 = DOE Flat Gasket	B = Buna		CS = 316SS Compression Spring
	0.1		20" (50.8 cm)		3 = 222 w/ Fin	E = EPDM		HP = Heavy Poly Core
	0.2		30" (76.2 cm)		4 = 222 w/ Flat Cap	S = Silicone		I = Stainless Steel Insert
	0.45		40" (101.6 cm)		6 = 226 w/ Flat Cap	T = Teflon® Encapsulated Viton®		R = 18 Megaohm Rinse
	0.65				7 = 226 w/ Fin	V = Viton®		
	0.8				16 = 213 Internal O-Ring	Z = Teflon® Encapsulated Silicone		
					28 = 222 3-tabs w/ Fin			

DISCLAIMER: Filtration data presented is representative of performance observed in controlled laboratory testing. It is not given as a warranty, specification or statement of fitness for use. Specific performance can vary widely depending on contaminant type, fluid properties, flow rates and environmental conditions. It is recommended that users conduct thorough qualification testing to assure the product functions as required.

DS\_GWPES\_190918

## WCPEs-Series WaterClear™ Polyethersulfone

### WCPEs-Series High Purity WaterClear™

Polyethersulfone Filter Cartridges are a value-oriented, reduced surface area choice for cost effective, general purpose membrane filtration. Designed in continuous lengths up to 30" for excellent performance value. The highly retentive polyethersulfone membrane offers excellent flux density and low protein-binding. The naturally hydrophilic membrane wets easily to allow for the maximum utilization of the surface area. These features allow the WCPEs-Series to provide the fine performance of PES membrane at a competitive price.

Designed to tolerate repeated hot water sanitization and in-situ steam sterilization cycles. Manufactured in a clean-room environment to maintain high standards of purity and cleanliness.

### Flow Rate vs Pressure Drop

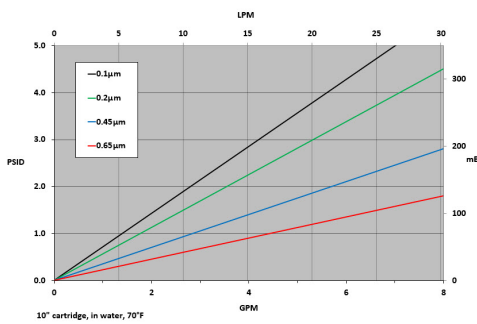

### Typical Applications

- Deionized Water Systems
- General-Use Water Filtration
- Liquid Clarification
- Chemical Filtration

### Ordering Information

WCPEs	Rating (µ)	A	Length	C	End Cap Style	O-Rings/Gaskets	-	Adders
	0.1		10" (5.4 cm)		2= DOE Flat Gasket	B = Buna		CS = 316SS Compression Spring
	0.2		20" (50.8 cm)		3= 222 w/ Fin	E = EPDM		R = 18 Megaohm Rinse
	0.45		30" (76.2 cm)		4 = 222 w/ Flat Cap	S = Silicone		
	0.65				6 = 226 w/ Flat Cap	T = Teflon® Encapsulated Viton®		
					7 = 226 w/ Fin	V = Viton®		
					16 = 213 Internal O-Ring	Z = Teflon® Encapsulated Silicone		
					28 = 222 3-tabs w/ Fin			

DISCLAIMER: Filtration data presented is representative of performance observed in controlled laboratory testing. It is not given as a warranty, specification or statement of fitness for use. Specific performance can vary widely depending on contaminant type, fluid properties, flow rates and environmental conditions. It is recommended that users conduct thorough qualification testing to assure the product functions as required. For additional technical support, a product Performance Guide is available upon request.

DS\_WCPES\_190918



### Construction Materials

**Membrane**..... Polyethersulfone  
**Support Media**..... Polypropylene  
**End Caps**..... Polypropylene  
**Center Core**..... Polypropylene  
**Outer Support Cage**..... Polypropylene  
**O-Rings/Gaskets**..... Buna, EPDM, Silicone,  
 Teflon® Encapsulated Viton®, Viton®,  
 Teflon® Encapsulated Silicone

### Sanitization/Sterilization

**Filtered Hot Water**.....80°C for 30 min.  
**Steam Sterilization** .....121°C for 30 min.,  
 multiple cycles

**Chemicals:** Cartridges are compatible with most chemical sanitizing agents.

**Note:** Stainless steel insert required for all cartridges being hot water sanitized or steam sterilized.

### Dimensions

**Length:**  
 10 to 30 inches (25.4 to 101.6 cm) nominal  
**Outside Diameter:**  
 2.70 inches (7.0 cm) nominal

### Operating Conditions

**Change Out ΔP (recommended)**.....35 PSID  
**Temperature (max)**.....176°F (80°C)  
**Differential Pressure (max)**.....50 PSID  
 (3.4 bar) at 68°F (20°C)

### Toxicity

All polypropylene components meet the specifications for biological safety per USP Class IV – 121°C for plastics.

### FDA Listed Materials

Materials of construction comply with FDA regulations for food and beverage contact use as detailed in the US Code of Federal Regulations, 21CFR. Materials used to produce filter media and hardware are deemed safe for use in contact with foodstuffs in accordance with EU Directives 2002/72/EC, 1935/2004, and/or 10/2011.



## GGPES-Series General Grade Polyethersulfone

GGPES-Series High Purity General Grade Polyethersulfone Filter Cartridges are a well-suited choice for cost effective, general purpose membrane filtration. The highly retentive polyethersulfone membrane offers excellent flux density and low protein-binding. The naturally hydrophilic membrane wets easily to allow maximum utilization of the entire surface. These features coupled with its extended filtration area allow the GGPES-Series to provide lower pressure loss and longer service life versus comparable products. Designed to tolerate repeated hot water sanitization and *in-situ* steam sterilization cycles. Manufactured in a clean-room environment to maintain high standards of purity and cleanliness.



### Flow Rate vs Pressure Drop

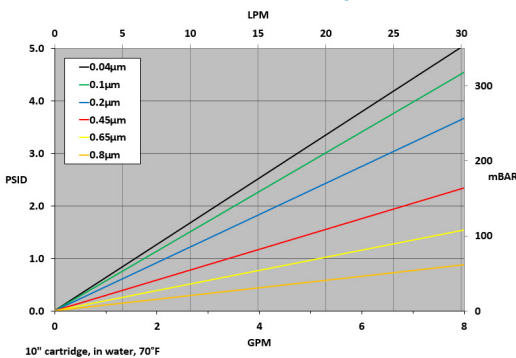

### Typical Applications

- Deionized Water Systems
- General-Use Water Filtration
- Liquid Clarification
- Recirculating Fluids
- Chemical Filtration

### Ordering Information

GGPES	Rating (µ)	A	Length	C	End Cap Style	O-Rings/Gaskets	-	Adders
	0.04		10" (25.4 cm)		2 = DOE Flat Gasket	B = Buna		CS = 316SS Compression Spring
	0.1		20" (50.8 cm)		3 = 222 w/ Fin	E = EPDM		I = Stainless Steel Insert
	0.2		30" (76.2 cm)		4 = 222 w/ Flat Cap	S = Silicone		
	0.45		40" (101.6 cm)		6 = 226 w/ Flat Cap	T = Teflon® Encapsulated Viton®		
	0.65				7 = 226 w/ Fin	V = Viton®		
	0.8				16 = 213 Internal O-Ring	Z = Teflon® Encapsulated Silicone		
					28 = 222 3-tabs w/ Fin			

DISCLAIMER: Filtration data presented is representative of performance observed in controlled laboratory testing. It is not given as a warranty, specification or statement of fitness for use. Specific performance can vary widely depending on contaminant type, fluid properties, flow rates and environmental conditions. It is recommended that users conduct thorough qualification testing to assure the product functions as required. For additional technical support, a product Performance Guide is available upon request.

DS\_GGPES\_190918

### Construction Materials

**Membrane**..... Polyethersulfone  
**Support Media**..... Polypropylene  
**End Caps**..... Polypropylene  
**Center Core**..... Polypropylene  
**Outer Support Cage**..... Polypropylene  
**O-Rings/Gaskets**..... Buna, EPDM, Silicone, Teflon® Encapsulated Viton®, Viton®, Teflon® Encapsulated Silicone

### Sanitization/Sterilization

**Filtered Hot Water**.....80°C for 30 min.  
**Steam Sterilization**.....121°C for 30 min., multiple cycles

**Chemicals:** Cartridges are compatible with most chemical sanitizing agents.

**Note:** Stainless steel insert required for all cartridges being hot water sanitized or steam sterilized.

### Toxicity

All polypropylene components meet the specifications for biological safety per USP Class VI – 121°C for plastics.

### Dimensions

**Length:** 10 to 40 inches (25.4 to 101.6 cm) nominal  
**Outside Diameter:** 2.70 inches (7.0 cm) nominal

### Operating Conditions

**Change Out ΔP (recommended)**.....35 PSID  
**Temperature (max)**.....176°F (80°C)  
**Differential Pressure (max)**.....50 PSID (3.4 bar) at 68°F (20°C)

### Food Safety Compliance

Materials of construction comply with FDA regulations for food and beverage contact use as detailed in the US Code of Federal Regulations, 21CFR. Materials used to produce filter media and hardware are deemed safe for use in contact with foodstuffs in accordance with EU Directives 2002/72/EC, 1935/2004, and/or 10/2011.

## GEPEs-Series Electronics Grade Polyethersulfone

GEPEs-Series High Purity Electronics Grade Polyethersulfone Filter Cartridges meet the stringent requirements of cleanliness of the micro-electronics industry. The polyethersulfone membrane offers high flux density and provides superior throughput for an extended operating life. Cartridges undergo extended flushing with 18 megaohm ultra-high purity water to achieve extraordinarily low levels of extractable substances. Each element is integrity tested for optimized, highly consistent performance. Manufactured in a clean-room environment to maintain high standards of purity and cleanliness.



### Flow Rate vs Pressure Drop

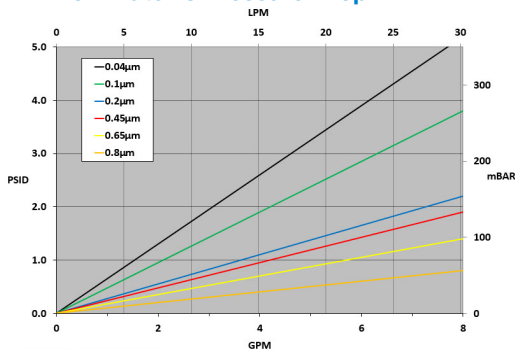

### Typical Applications

- Ultra-Pure Water Systems
- Fine Chemical Filtration
- Photoresist Chemicals

### Construction Materials

**Membrane**..... Polyethersulfone  
**Support Media**..... Polypropylene  
**End Caps**..... Polypropylene  
**Center Core**..... Polypropylene  
**Outer Support Cage**..... Polypropylene  
**O-Rings/Gaskets**..... Buna, EPDM, Silicone, Teflon® Encapsulated Viton®, Viton®, Teflon® Encapsulated Silicone

### Sanitization/Sterilization

**Filtered Hot Water**.....80°C for 30 min.  
**Steam Sterilization**.....121°C for 30 min., multiple cycles

**Chemicals:** Cartridges are compatible with most chemical sanitizing agents.

**Note:** Stainless steel insert option required for all cartridges being hot water sanitized or steam sterilized.

### Dimensions

#### Length:

10 to 40 inches (25.4 to 101.6 cm) nominal

#### Outside Diameter:

2.70 inches (7.0 cm) nominal

### Operating Conditions

**Change Out ΔP (recommended)**.....35 PSID  
**Temperature (max)**.....176°F (80°C)  
**Differential Pressure (max)**.....50 PSID (3.4 bar) at 68°F (20°C)

### Toxicity

All polypropylene components meet the specifications for biological safety per USP Class VI – 121°C for plastics.

### Food Safety Compliance

Materials of construction comply with FDA regulations for food and beverage contact use as detailed in the US Code of Federal Regulations, 21CFR. Materials used to produce filter media and hardware are deemed safe for use in contact with foodstuffs in accordance with EU Directives 2002/72/EC, 1935/2004, and/or 10/2011.

### Ordering Information

GEPEs	Rating (µ)	A	Length	C	End Cap Style	O-Rings/Gaskets	-	Adders
	0.04		10" (25.4 cm)		2 = DOE Flat Gasket	B = Buna		CS = 316SS Compression Spring
	0.1		20" (50.8 cm)		3 = 222 w/ Fin	E = EPDM		I = Stainless Steel Insert
	0.2		30" (76.2 cm)		4 = 222 w/ Flat Cap	S = Silicone		
	0.45		40" (101.6 cm)		6 = 226 w/ Flat Cap	T = Teflon® Encapsulated Viton®		
	0.65				7 = 226 w/ Fin	V = Viton®		
	0.8				16 = 213 Internal O-Ring	Z = Teflon® Encapsulated Silicone		
					28 = 222 3-tabs w/ Fin			

DISCLAIMER: Filtration data presented is representative of performance observed in controlled laboratory testing. It is not given as a warranty, specification or statement of fitness for use. Specific performance can vary widely depending on contaminant type, fluid properties, flow rates and environmental conditions. It is recommended that users conduct thorough qualification testing to assure the product functions as required. For additional technical support, a product Performance Guide is available upon request.

DS\_GEPEs\_190918

## GFPEs-Series Food and Beverage Grade Polyethersulfone

GFPEs-Series High Purity Food and Beverage Grade Polyethersulfone Filter Cartridges meet the most demanding requirement of the food and beverage industry. The polyethersulfone membrane offers high flux density and low protein-binding and maintains the organoleptic characteristics of the treated product, making it an ideal choice for production of consumables. Cartridges are flushed with ultra-High Purity water to achieve the most stringent requirements for extractable substances. Designed to tolerate repeated hot water sanitization and *in-situ* steam sterilization cycles for maximum service life. Each element is diffusion tested for integrity to assure optimal performance. Manufactured in a clean-room environment to maintain high standards of purity and cleanliness.

### Microbial Retention Performance

Rating	Challenge Microbe	Log Reduction Value (LRV)
0.2µ	<i>Brevundimonas diminuta</i>	7.6
0.45µ	<i>Serratia marcescens</i>	6.6
0.65µ	<i>Saccharomyces cerevisiae</i>	4.8

\* Independently tested in accordance with ASTM F838.

### Flow Rate vs Pressure Drop

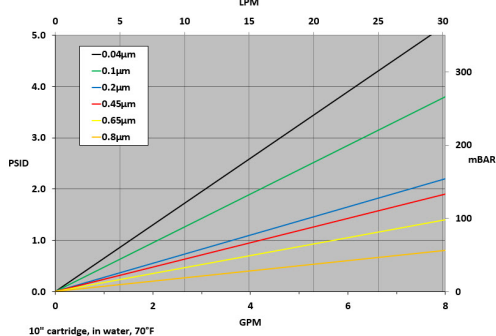

### Construction Materials

**Membrane**..... Polyethersulfone  
**Support Media**..... Polypropylene  
**End Caps**..... Polypropylene  
**Center Core**..... Polypropylene  
**Outer Support Cage**..... Polypropylene  
**O-Rings/Gaskets**..... Buna, EPDM, Silicone, Teflon® Encapsulated Viton®, Viton®, Teflon® Encapsulated Silicone

### Sanitization/Sterilization

**Filtered Hot Water**.....80°C for 30 min.  
**Steam Sterilization**.....121°C for 30 min., multiple cycles

**Chemicals:** Cartridges are compatible with most chemical sanitizing agents.

**Note:** Stainless steel insert option required for all cartridges being hot water sanitized or steam sterilized.

### Typical Applications

- Wine
- Beer
- Juices
- Soft Drinks
- Bottled Water

### Dimensions

**Length:** 10 to 40 inches (25.4 to 101.6 cm) nominal  
**Outside Diameter:** 2.70 inches (7.0 cm) nominal

### Operating Conditions

**Change Out ΔP (recommended)**.....35 PSID  
**Temperature (max)**.....176°F (80°C)  
**Differential Pressure (max)** ..... 50 PSID (3.4 bar) at 68°F (20°C)

### Toxicity

All polypropylene components meet the specifications for biological safety per USP Class VI – 121°C for plastics.

### Food Safety Compliance

Materials of construction comply with FDA regulations for food and beverage contact use as detailed in the US Code of Federal Regulations, 21CFR. Materials used to produce filter media and hardware are deemed safe for use in contact with foodstuffs in accordance with EU Directives 2002/72/EC, 1935/2004, and/or 10/2011.

### Ordering Information

GFPEs	Rating (µ)	A	Length	C	End Cap Style	O-Rings/Gaskets	Adders
	0.04		10" (25.4 cm)		2 = DOE Flat Gasket	B = Buna	CS = 316SS Compression Spring
	0.1		20" (50.8 cm)		3 = 222 w/ Fin	E = EPDM	I = Stainless Steel Insert
	0.2		30" (76.2 cm)		4 = 222 w/ Flat Cap	S = Silicone	
	0.45		40" (101.6 cm)		6 = 226 w/ Flat Cap	T = Teflon® Encapsulated Viton®	
	0.65				7 = 226 w/ Fin	V = Viton®	
	0.8				16 = 213 Internal O-Ring	Z = Teflon® Encapsulated Silicone	
					28 = 222 3-tabs w/ Fin		

DISCLAIMER: Filtration data presented is representative of performance observed in controlled laboratory testing. It is not given as a warranty, specification or statement of fitness for use. Specific performance can vary widely depending on contaminant type, fluid properties, flow rates and environmental conditions. It is recommended that users conduct thorough qualification testing to assure the product functions as required. For additional technical support, a product Performance Guide is available upon request.

DS\_GFPEs\_190918

## GBPES-Series Wine and Beverage Grade Polyethersulfone

GBPES-Series High Purity Wine and Beverage Grade Polyethersulfone Filter Cartridges are optimized for the requirements of the wine and beverage industry. The polyethersulfone membrane offers high flux density and low protein-binding and maintains the organoleptic characteristics of the treated product, making it an ideal choice for production of consumables. Cartridges are flushed with ultra-High Purity water to achieve the most stringent requirements for extractable substances. Designed to tolerate repeated hot water sanitization and *in situ* steam sterilization cycles for maximum service life. Each element is diffusion tested for integrity to assure optimal performance. Manufactured in a clean-room environment to maintain high standards of purity and cleanliness.

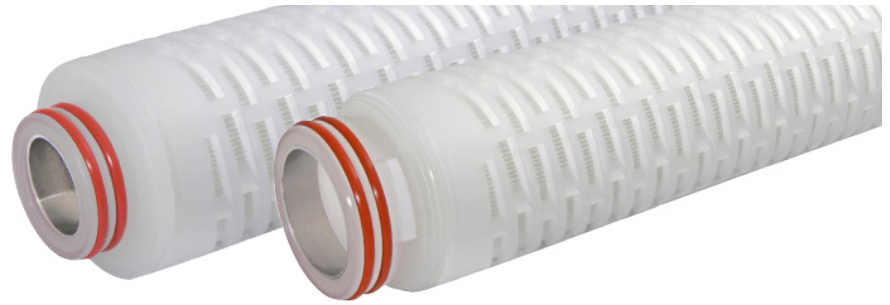

### Microbial Retention Performance

Rating	Challenge Microorganism	LRV
0.2μ	<i>Serratia marcescens</i>	6.6
0.45μ	<i>Sacchromyces cerevisiae</i>	4.8

\* Independently tested in accordance with ASTM F838.

### Flow Rate vs Pressure Drop

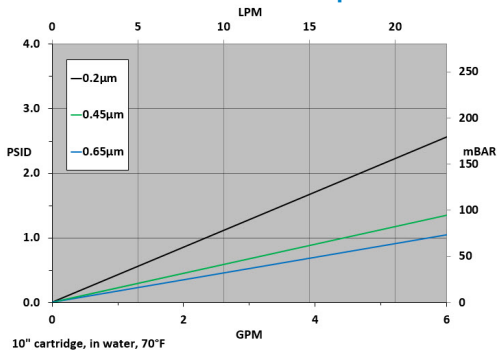

### Typical Applications

- Wine
- Beer
- Juices
- Soft Drinks
- Bottled Water

### Construction Materials

**Membrane**..... Polyethersulfone  
**Support Media**..... Polypropylene  
**End Caps**..... Polypropylene  
**Cages and Cores**..... Polypropylene  
**O-Rings/Gaskets**..... Buna, EPDM, Silicone, Teflon® Encapsulated Viton®, Viton®, Teflon® Encapsulated Silicone

### Sanitization/Sterilization

**Hot Water**.....85-95°C, 30 min., max dP 7 PSI  
**Steam Sterilization**.....134°C for 30 min., max dP 7 psi, multiple cycles

**Note:** All cartridges provided standard with an integral stainless steel reinforcement ring to prevent deformation of the o-ring adapter during steam sterilization or hot water sanitization processes.

**Chemicals:** Peracetic acid, chlorinated alkaline products, bleach, sulfur dioxide and hydrogen peroxide at typical sanitization concentrations and temperatures.

### Dimensions

**Length**.....10 to 40 inches  
 (25.4 to 101.6 cm) nominal  
**Outside Diameter**..... 2.70 inches  
 (7.0 cm) nominal

### Operating Conditions

**Change Out ΔP (recommended)**.....35 PSID  
**Temperature (max)**.....176°F (80°C)  
**Differential Pressure (max)**.....72 PSID  
 (5.0 bar) at 68°F (20°C)

### Toxicity

All polypropylene components meet the specifications for biological safety per USP Class VI – 121°C for plastics.

### Food Safety Compliance

Materials of construction comply with FDA regulations for food and beverage contact use as detailed in the US Code of Federal Regulations, 21CFR. Materials used to produce filter media and hardware are deemed safe for use in contact with foodstuffs in accordance with EU Directives 2002/72/EC, 1935/2004, and/or 10/2011.

### Ordering Information

GBPES	Rating (μ)	A	Length	C	End Cap Style	O-Rings/Gaskets	-	Adders
	0.2		10" (25.4 cm)		2 = DOE Flat Gasket	B = Buna		CS = 316SS Compression Spring
	0.45		20" (50.8 cm)		3 = 222 w/ Fin	E = EPDM		
	0.65		30" (76.2 cm)		4 = 222 w/ Flat Cap	S = Silicone		
			40" (101.6 cm)		6 = 226 w/ Flat Cap	T = Teflon® Encapsulated Viton®		
					7 = 226 w/ Fin	V = Viton®		
					28 = 222 3-tabs w/ Fin	Z = Teflon® Encapsulated Silicone		

DISCLAIMER: Filtration data presented is representative of performance observed in controlled laboratory testing. It is not given as a warranty, specification or statement of fitness for use. Specific performance can vary widely depending on contaminant type, fluid properties, flow rates and environmental conditions. It is recommended that users conduct thorough qualification testing to assure the product functions as required. For additional technical support, a product Validation Guide is available upon request.

DS\_GBPES\_190918



## GD PES-Series DuoGrade™ Serial Layer Polyethersulfone

### GD PES-Series DuoGrade™ Serial Layer

Polyethersulfone Filter Cartridges deliver extended life and excellent retention. Featuring a Microglass prefiltration layer, this serial construction makes the GD PES an ideal choice for clarification of particulate-heavy solutions in a variety of food/ beverage, pharmaceutical, biological, and chemical applications. With excellent flowrates, low pressure drops, and superior throughput volumes, GD PES cartridges can be used as final filters or to protect downstream sterilizing grade cartridges. Each cartridge is flushed with 18 megaohm High Purity deionized water and is integrity tested to ensure the delivery of clean effluent with low extractables. Designed to tolerate repeated hot water sanitization and *in-situ* steam sterilization cycles for maximum service life.

### Microbial Retention Performance

Rating	Challenge Microbe	Log Reduction Value (LRV)
0.2µ	<i>Brevundimonas diminuta</i>	7.6
0.45µ	<i>Serratia marcescens</i>	6.6
0.65µ	<i>Saccharomyces cerevisiae</i>	4.8

\* Independently tested in accordance with ASTM F838.

### Flow Rate vs Pressure Drop

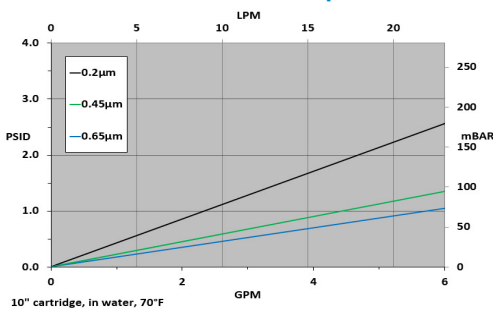

### Typical Applications

- Wine, Beer, & Spirits
- Bottled Water, Juices, Soft Drinks
- Cell Culture Media
- Large Volume Parenterals
- Bulk Pharmaceutical Solutions

### Construction Materials

**Membrane**..... Polyethersulfone  
**Support Media**..... Microglass  
**End Caps**..... Polypropylene  
**Center Core**..... Polypropylene  
**Outer Support Cage**..... Polypropylene  
**O-Rings/Gaskets**..... Buna, EPDM, Silicone, Teflon® Encapsulated Viton®, Viton®, Teflon® Encapsulated Silicone

### Sanitization/Sterilization

**Filtered Hot Water**..... 80°C for 30 min.  
**Steam Sterilization**..... 121°C for 30 min., multiple cycles  
**Chemicals:** Cartridges are compatible with most chemical sanitizing agents.  
**Note:** Stainless steel insert option required for all cartridges being hot water sanitized or steam sterilized.

### Dimensions

**Length:**  
 10 to 40 inches (25.4 to 101.6 cm) nominal  
**Outside Diameter:**  
 2.70 inches (7.0 cm) nominal

### Operating Conditions

**Change Out ΔP (recommended)**..... 35 PSID  
**Temperature (max)**..... 176°F (80°C)  
**Differential Pressure (max)**..... 50 PSID (3.4 bar) at 68°F (20°C)

### Toxicity

All polypropylene components meet the specifications for biological safety per USP Class VI – 121°C for plastics.

### Food Safety Compliance

Materials of construction comply with FDA regulations for food and beverage contact use as detailed in the US Code of Federal Regulations, 21CFR. Materials used to produce filter media and hardware are deemed safe for use in contact with foodstuffs in accordance with EU Directives 2002/72/EC, 1935/2004, and/or 10/2011.

### Ordering Information

GD PES	Rating (µ)	A	Length	C	End Cap Style	O-Rings/Gaskets	-	Adders
	0.2		10" (25.4 cm)		2 = DOE Flat Gasket	B = Buna		CS = 316SS Compression Spring
	0.45		20" (50.8 cm)		3 = 222 w/ Fin	E = EPDM		I = Stainless Steel Insert
	0.65		30" (76.2 cm)		4 = 222 w/ Flat Cap	S = Silicone		
			40" (101.6 cm)		6 = 226 w/ Flat Cap	T = Teflon® Encapsulated Viton®		
					7 = 226 w/ Fin	V = Viton®		
					16 = 213 Internal O-Ring	Z = Teflon® Encapsulated Silicone		
					28 = 222 3-tabs w/ Fin			

DISCLAIMER: Filtration data presented is representative of performance observed in controlled laboratory testing. It is not given as a warranty, specification or statement of fitness for use. Specific performance can vary widely depending on contaminant type, fluid properties, flow rates and environmental conditions. It is recommended that users conduct thorough qualification testing to assure the product functions as required. For additional technical support, a product Performance Guide is available upon request.

DS\_GDPES\_190918



## GSPES-Series Serial-Layer Polyethersulfone

GSPES filter cartridges deliver extended service life and excellent retention. The serial-layer design makes the GSPES an ideal choice for the clarification or particulate-heavy solutions in a wide variety of food & beverage, pharmaceutical, biological, and high purity chemical applications. The GSPES series is available in 0.2, 0.45, & 0.65 micron ratings. The serial-layer design offers superior throughput volumes while protecting downstream sterilizing grade cartridges.



### Flow Rate vs Pressure Drop

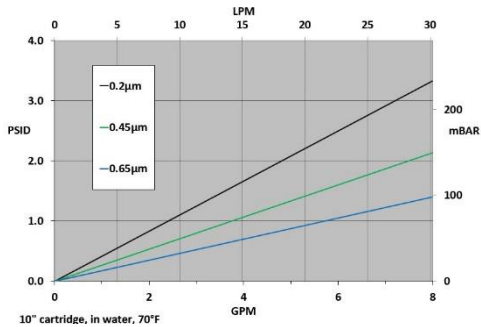

### Typical Applications

- Bottled Water, Juices, Soft Drinks
- Wine, Beer, Spirits
- Bulk Pharmaceutical Solutions
- Bulk & Fine Chemicals

### Operating Conditions

**Change Out  $\Delta P$  (recommended)**...35 PSID  
**Temperature (max)**.....176°F (80°C)  
**Differential Pressure (max)**.....50 PSID

### Construction Materials

**Membrane**..... Polyethersulfone  
**Support Media**..... Polypropylene  
**End Caps**..... Polypropylene  
**Center Core**..... Polypropylene  
**Outer Support Cage**..... Polypropylene  
**O-Rings/Gaskets**..... Buna, EPDM, Silicone, Viton®, Teflon® Encapsulated Viton®

### Sanitization/Sterilization

**Filtered Hot Water**.....85°C for 30 min  
**Steam Sterilization**.....121°C for 30 min., Multiple cycles

**Chemicals:** Cartridges are chemically compatible with most chemicals and sanitizing agents.

**Note:** Stainless steel insert option needed for all cartridges being hot water sanitized or steam sterilized.

### Dimensions

**Length:** 10 to 40 inches (25.4 to 101.6 cm) nominal  
**Outside Diameter:** 2.70 inches (7.0 cm) nominal

### Toxicity

All polypropylene components meet the specifications for biological safety per USP Class VI – 121°C for plastics.

### Food Safety Compliance

Materials of construction comply with FDA regulations for food and beverage contact use as detailed in the US Code of Federal Regulations, 21CFR. Materials used to produce filter media and hardware are deemed safe for use in contact with foodstuffs in accordance with EU Directives 2002/72/EC, 1935/2004, and/or 10/2011.

### Ordering Information

GSPES	Rating (µ)	A	Length	C	End Cap Style	O-Rings/Gaskets	-	Adders
	0.2		10" (25.4 cm)		2 = DOE Flat Gasket	B = Buna-N		CS = 316SS Compression Spring
	0.45		20" (50.8 cm)		3 = 222 w/ Fin	E = EPDM		I = Stainless Steel Insert
	0.65		30" (76.2 cm)		4 = 222 w/ Flat Cap	S = Silicone		
			40" (101.6 cm)		6 = 226 w/ Flat Cap	T = Teflon® Encapsulated Viton®		
					7 = 226 w/ Fin	V = Viton®		
					16 = 213 Internal O-Ring	Z = Teflon® Encapsulated Silicone		
					28 = 222 3-tabs w/ Fin			

DISCLAIMER: Filtration data presented is representative of performance observed in controlled laboratory testing. It is not given as a warranty, specification or statement of fitness for use. Specific performance can vary widely depending on contaminant type, fluid properties, flow rates and environmental conditions. It is recommended that users conduct thorough qualification testing to assure the product functions as required. For additional technical support, a product Validation Guide is available upon request.

DS\_PPES\_190918

## BRPES-Series Bio-Burden Reduction Grade Polyethersulfone

BRPES-Series High Purity Bio-Burden Reduction Grade Filter Polyethersulfone Cartridges are validated and 100% integrity tested; providing bio-burden and small particle removal across a wide range of food & beverage, biological liquids, and intermediate bulk pharmaceutical fluids. The BRPES-Series is constructed using a unique single-layer hydrophilic asymmetric polyethersulfone membrane. This construction offers broad chemical compatibility, high flow-rates at low pressure drops, and low extractables. BRPES cartridges are ideal as either a final filtration stage or as an extremely effective prefilter to a sterilizing stage. Manufactured in a clean-room environment to maintain high standards of purity and cleanliness.



### Microbial Retention Performance

Rating	Challenge Microbe	Log Reduction Value (LRV)
0.2μ	<i>Brevundimonas diminuta</i>	>8.0
0.45μ	<i>Lactobacillus lindneri</i> , <i>Serratia marcescens</i>	>8.0
0.65μ	<i>Lactobacillus lindneri</i> , <i>Saccharomyces cerevisiae</i>	>8.0

\* Independently tested in accordance with ASTM F838.

### Flow Rate vs Pressure Drop

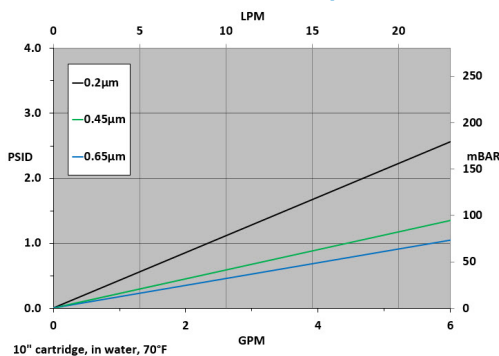

### Typical Applications

- Cell Culture Media
- Blood and Serum Fractions
- Large Volume Parenterals (LVP's)
- Purified Water
- Pharmaceutical Bulk Chemical Solutions
- Beer, Wine & Spirits
- Juice & Soft Drinks
- Diagnostics
- Bottled Water

### Construction Materials

- Membrane**..... Polyethersulfone
- Support Media**..... Polypropylene
- End Caps**..... Polypropylene
- Center Core**..... Polypropylene
- Outer Support Cage**..... Polypropylene
- O-Rings/Gaskets**..... Buna, EPDM, Silicone, Teflon® Encapsulated Viton®, Viton®, Teflon® Encapsulated Silicone

**Note:** O-ring adapters include integral reinforcement ring that will not deform with repeated steam sterilization or hot water sanitation cycles.

### Dimensions

- Length:** 10 to 40 inches (25.4 to 101.6 cm) nominal
- Outside Diameter:** 2.78 inches (7.06 cm) nominal

### Operating Conditions

- Change Out ΔP (recommended)**.....35 PSID
- Temperature (max)**.....176°F (80°C)
- Differential Pressure (max)**.....72 PSID (5.0 bar) at 68°F (20°C)

### Sterilization

- Hot Water**.....85°- 95°C, 30 min., max. ΔP 7 psi
- In-Line Steaming**.....134°C, 30 min., max. ΔP 7 psi; 100 cycles

### Toxicity

All polypropylene components meet the specifications for biological safety per USP Class IV – 121°C for plastics.

### Food Safety Compliance

Materials of construction comply with FDA regulations for food and beverage contact use as detailed in the US Code of Federal Regulations, 21CFR. Materials used to produce filter media and hardware are deemed safe for use in contact with foodstuffs in accordance with EU Directives 2002/72/EC, 1935/2004, and/or 10/2011.

### Ordering Information

BRPES	Rating (μ)	A	Length	C	End Cap Style	O-Rings/Gaskets
	0.2		10" (25.4 cm)		2 = DOE Flat Gasket	B = Buna-N
	0.45		20" (50.8 cm)		3 = 222 w/ Fin	E = EPDM
	0.65		30" (76.2 cm)		4 = 222 w/ Flat Cap	S = Silicone
			40" (101.6 cm)		6 = 226 w/ Flat Cap	T = Teflon® Encapsulated Viton®
					7 = 226 w/ Fin	V = Viton®
					28 = 222 3-tabs w/ Fin	Z = Teflon® Encapsulated Silicone

DISCLAIMER: Filtration data presented is representative of performance observed in controlled laboratory testing. It is not given as a warranty, specification or statement of fitness for use. Specific performance can vary widely depending on contaminant type, fluid properties, flow rates and environmental conditions. It is recommended that users conduct thorough qualification testing to assure the product functions as required. For additional technical support, a product Validation Guide is available upon request.

DS\_BRPES\_190918

## PPES-Series Pharmaceutical Grade Polyethersulfone

PPES-Series High Purity Pharmaceutical Grade Polyethersulfone Filter Cartridges are ideal for sterile filtration and clarification of pharmaceutical and biological solutions. Each PPES cartridge is integrity tested during manufacturing and is supported by a validation guide for regulatory compliance. Low protein binding and the broad chemical compatibility characteristics of the polyethersulfone membrane, along with exceptional flow rate vs pressure drop, makes the PPES-Series the ideal choice for a variety of valuable and/or critical pharmaceutical solutions.

PPES cartridges are fully validated as sterilizing grade filters in accordance with HIMA and ASTM F838-05 guidelines. For the 0.2 micron series elements, validation studies demonstrate sterile effluent is achieved with challenge concentrations in excess of  $10^7$ , *Brevundimonas diminuta* per  $\text{cm}^2$  of filter area. Additionally, validation studies of 0.1 micron series elements demonstrate  $10^7$  retention of *Mycoplasma (Acholeplasma laidlawii)* per  $\text{cm}^2$  of filter area. Designed to tolerate repeated hot water sanitization and *in-situ* steam sterilization cycles for maximum service life. Manufactured in a clean-room environment to maintain high standards of purity and cleanliness.



### Flow Rate vs Pressure Drop

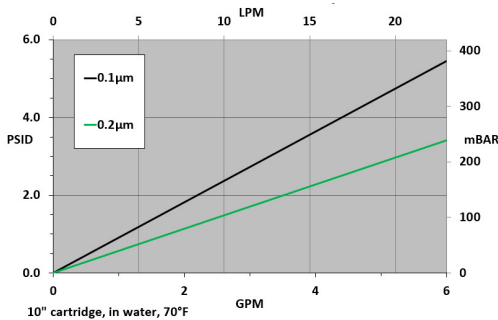

### Typical Applications

- Vaccines
- Large Volume Parenteral (LVP's)
- Water for Injection (WFI)
- Diagnostics
- Ophthalmics
- Cell and Tissue Culture Media
- Protein Solutions
- Serum and Blood Products

### Construction Materials

**Membrane**..... Polyethersulfone  
**Support Media**..... Polypropylene  
**End Caps**..... Polypropylene  
**Center Core**..... Polypropylene  
**Outer Support Cage**..... Polypropylene  
**O-Rings/Gaskets**..... Buna, EPDM, Silicone, Teflon® Encapsulated Viton®, Viton®, Teflon® Encapsulated Silicone

**Note:** O-ring adapters include integral reinforcement that will not deform with repeated steam sterilization or hot water sanitation cycles.

### Toxicity

All polypropylene components meet the specifications for biological safety per USP Class VI – 121°C for plastics.

### Sterilization

**Hot Water**.....85°- 95°C, 30 min., max. ΔP 7 psi  
**In-Line Steaming**.....134°C, 30 min., max. ΔP 7 psi; 100 cycles

### Dimensions

**Length:**  
10 to 40 inches (25.4 to 101.6 cm) nominal  
**Outside Diameter:**  
2.78 inches (7.06 cm) nominal

### Operating Conditions

**Change Out ΔP (recommended)**.....35 PSID  
**Temperature (max)**.....176°F (80°C)  
**Differential Pressure (max)**.....72 PSID (5.0 bar) at 68°F (20°C)

### Food Safety Compliance

Materials of construction comply with FDA regulations for food and beverage contact use as detailed in the US Code of Federal Regulations, 21CFR. Materials used to produce filter media and hardware are deemed safe for use in contact with foodstuffs in accordance with EU Directives 2002/72/EC, 1935/2004, and/or 10/2011.

### Ordering Information

PPES	Rating (µ)	A	Length	C	End Cap Style	O-Rings/Gaskets
	0.1		10" (25.4 cm)		2 = DOE Flat Gasket	B = Buna-N
	0.2		20" (50.8 cm)		3 = 222 w/ Fin	E = EPDM
			30" (76.2 cm)		4 = 222 w/ Flat Cap	S = Silicone
			40" (101.6 cm)		6 = 226 w/ Flat Cap	T = Teflon® Encapsulated Viton®
					7 = 226 w/ Fin	V = Viton®
					28 = 222 3-tabs w/ Fin	Z = Teflon® Encapsulated Silicone

DISCLAIMER: Filtration data presented is representative of performance observed in controlled laboratory testing. It is not given as a warranty, specification or statement of fitness for use. Specific performance can vary widely depending on contaminant type, fluid properties, flow rates and environmental conditions. It is recommended that users conduct thorough qualification testing to assure the product functions as required. For additional technical support, a product Validation Guide is available upon request.

DS\_PPES\_190918

## GGHNY-Series General Grade Nylon and Plus+ Nylon

GGHNY-Series High Purity General Grade Nylon and Plus+ Nylon Filter Cartridges, featuring Nylon 6,6 membrane, provide excellent particulate retention and cleanliness for general use applications. Nylon 6,6 membrane has performed successfully over many decades, establishing a legacy of proven performance value. The optional positive zeta potential surface charge (Plus+) enhances retention performance for particulate well smaller than the stated micron rating, for applications that may include removal of haze, color bodies, and endotoxins. Manufactured in a clean-room environment to maintain high standards of purity and cleanliness.

### Flow Rate vs Pressure Drop

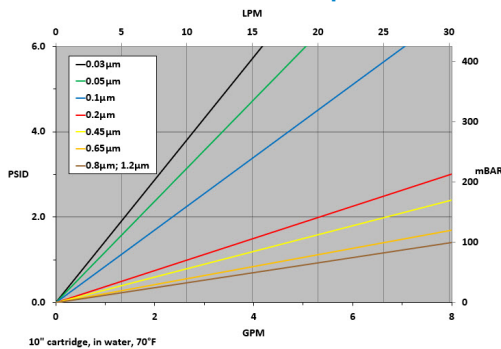

### Typical Applications

- Drinking Water
- Wine
- Soft Drinks
- Pharmaceutical
- Fermentation
- Endotoxin Removal

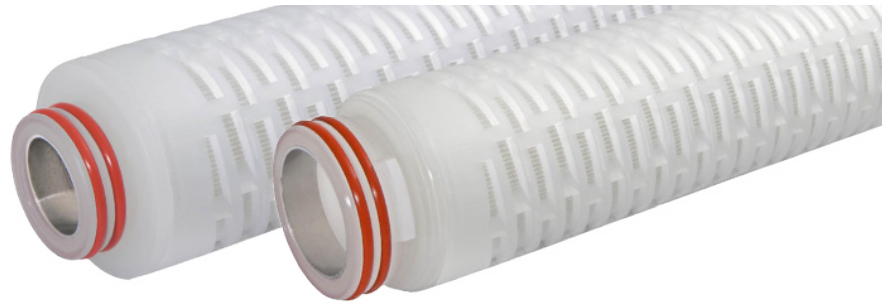

### Construction Materials

**Membrane**.....Nylon 6,6  
**Support Media**.....Polypropylene  
**End Caps**.....Polypropylene  
**Center Core**.....Polypropylene  
**Outer Support Cage**.....Polypropylene  
**O-Rings/Gaskets**.....Buna, EPDM, Silicone, Teflon® Encapsulated Viton®, Viton®, Teflon® Encapsulated Silicone

### Sanitization/Sterilization

**Filtered Hot Water**.....80°C for 30 min.  
**Steam Sterilization**.....121°C for 30 min., multiple cycles

**Chemicals:** Cartridges are compatible with most chemical sanitizing agents.

**Note:** Stainless steel insert option required for all cartridges being hot water sanitized or steam sterilized.

### Dimensions

**Length:** 10 to 40 inches (25.4 to 101.6 cm) nominal  
**Outside Diameter:** 2.70 inches (7.0 cm) nominal

### Operating Conditions

**Change Out ΔP (recommended)**.....35 PSID  
**Temperature (max)**.....176°F (80°C)  
**Differential Pressure (max)**.....50 PSID (3.4 bar) at 68°F (20°C)

### Toxicity

All polypropylene components meet the specifications for biological safety per USP Class VI – 121°C for plastics.

### Food Safety Compliance

Materials of construction comply with FDA regulations for food and beverage contact use as detailed in the US Code of Federal Regulations, 21CFR. Materials used to produce filter media and hardware are deemed safe for use in contact with foodstuffs in accordance with EU Directives 2002/72/EC, 1935/2004, and/or 10/2011.

### Ordering Information

GGHNY	Rating (μ)	A	Length	C	End Cap Style	O-Rings/Gaskets	-	Adders
GGHNY+	0.03		10" (25.4 cm)		2 = DOE Flat Gasket	B = Buna		CS = 316SS Compression Spring
	0.05		20" (50.8 cm)		3 = 222 w/ Fin	E = EPDM		I = Stainless Steel Insert
	0.1		30" (76.2 cm)		4 = 222 w/ Flat Cap	S = Silicone		
	0.2		40" (101.6 cm)		6 = 226 w/ Flat Cap	T = Teflon® Encapsulated Viton®		
	0.45				7 = 226 w/ Fin	V = Viton®		
	0.65				16 = 213 Internal O-Ring	Z = Teflon® Encapsulated Silicone		
	0.8				28 = 222 3-tabs w/ Fin			
	1.2							

DISCLAIMER: Filtration data presented is representative of performance observed in controlled laboratory testing. It is not given as a warranty, specification or statement of fitness for use. Specific performance can vary widely depending on contaminant type, fluid properties, flow rates and environmental conditions. It is recommended that users conduct thorough qualification testing to assure the product functions as required. For additional technical support, a product Performance Guide is available upon request.

DS\_GGHNY\_190918



## GEHNY-Series Electronics Grade Nylon and Plus+ Nylon

GEHNY-Series High Purity Electronics Grade Nylon and Plus+ Nylon Filter Cartridges, featuring nylon 6,6 membrane, provides superior particulate retention and cleanliness for production of ultra-pure water critical to the micro-electronics industry. The optional positive zeta potential surface charge (Plus+) enhances retention performance for particulate smaller than the stated micron rating.

Cartridges are manufactured in a clean room environment and undergo extended flushing with 18 megaohm ultra-high purity water to achieve extraordinarily low levels of extractable substances and provide quick rinse-up. Each element is diffusion tested for integrity to assure optimal performance.

### Flow Rate vs Pressure Drop

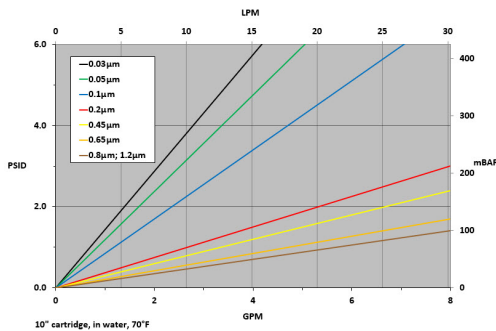

### Typical Applications

- UHP DI Water
- Ultrafine Chemicals
- Ion Exchange Resin Trap
- Point-of-Use Filters



### Construction Materials

**Membrane**.....Nylon 6,6  
**Support Media**.....Polypropylene  
**End Caps**.....Polypropylene  
**Center Core**.....Polypropylene  
**Outer Support Cage**.....Polypropylene  
**O-Rings/Gaskets**.....Buna, EPDM, Silicone, Clear Silicone, Teflon® Encapsulated Viton®, Viton®, Teflon® Encapsulated Silicone

### Sanitization/Sterilization

**Filtered Hot Water**.....80°C for 30 min.  
**Steam Sterilization**.....121°C for 30 min., multiple cycles

**Chemicals:** Cartridges are compatible with most chemical sanitizing agents.

**Note:** Stainless steel insert option required for all cartridges being hot water sanitized or steam sterilized.

### Dimensions

**Length:** 10 to 40 inches (25.4 to 101.6 cm) nominal  
**Outside Diameter:** 2.70 inches (7.0 cm) nominal

### Operating Conditions

**Change Out ΔP (recommended)**.....35 PSID  
**Temperature (max)**.....176°F (80°C)  
**Differential Pressure (max)**.....50 PSID (3.4 bar) at 68°F (20°C)

### Toxicity

All polypropylene components meet the specifications for biological safety per USP Class VI – 121°C for plastics.

### Food Safety Compliance

Materials of construction comply with FDA regulations for food and beverage contact use as detailed in the US Code of Federal Regulations, 21CFR. Materials used to produce filter media and hardware are deemed safe for use in contact with foodstuffs in accordance with EU Directives 2002/72/EC, 1935/2004, and/or 10/2011.

### Ordering Information

GEHNY	Rating (µ)	A	Length	C	End Cap Style	O-Rings/Gaskets	-	Adders
GEHNY+	0.03		10" (25.4 cm)		2 = DOE Flat Gasket	B = Buna		CS = 316SS Compression Spring
	0.05		20" (50.8 cm)		3 = 222 w/ Fin	C = Clear Silicone		I = Stainless Steel Insert
	0.1		30" (76.2 cm)		4 = 222 w/ Flat Cap	E = EPDM		
	0.2		40" (101.6 cm)		6 = 226 w/ Flat Cap	S = Silicone		
	0.45				7 = 226 w/ Fin	T = Teflon® Encapsulated Viton®		
	0.65				16 = 213 Internal O-Ring	V = Viton®		
	0.8				28 = 222 3-tabs w/ Fin	Z = Teflon® Encapsulated Silicone		
	1.2							

DISCLAIMER: Filtration data presented is representative of performance observed in controlled laboratory testing. It is not given as a warranty, specification or statement of fitness for use. Specific performance can vary widely depending on contaminant type, fluid properties, flow rates and environmental conditions. It is recommended that users conduct thorough qualification testing to assure the product functions as required. For additional technical support, a product Performance Guide is available upon request.

DS\_GEHNY\_190918

## GFHNY-Series Food and Beverage Grade Nylon and Plus+ Nylon

GFHNY-Series High Purity Food and Beverage Grade Nylon and Plus+ Nylon Filter Cartridges featuring nylon 6,6 membrane have a well-proven record of delivering superior microbial retention in the production of highly stable consumables. The optional positive zeta potential surface charge (Plus+) enhances retention performance for particulate well smaller than the stated micron rating, for applications that may include removal of haze, color bodies, and endotoxins. Cartridges are manufactured in a clean room environment and are flushed with 18 megaohm ultra-high purity water to achieve cleanliness and low extractables. Designed to tolerate repeated hot water sanitization and in situ steam sterilization cycles for maximum service life. Each element is diffusion tested for integrity to assure optimal performance.



### Microbial Retention Performance

Grade	Challenge Microbe	Log Reduction Value (LRV)
0.2 μ	<i>Brevundimonas diminuta</i>	9.1
0.45 μ	<i>Serratia marcescens</i>	11.0
0.65 μ	<i>Saccharomyces cerevisiae</i>	11.0

Independently tested in accordance with ASTM F838.

### Flow Rate vs Pressure Drop

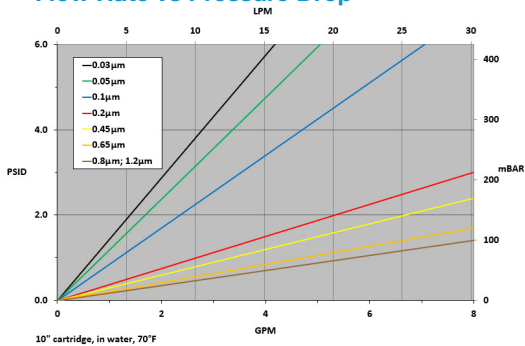

### Ordering Information

GFHNY	Rating (μ)	A	Length	C	End Cap Style	O-Rings/Gaskets	-	Adders
GFHNY+	0.03		10" (25.4 cm)		2 = DOE Flat Gasket	B = Buna		CS = 316SS Compression Spring
	0.05		20" (50.8 cm)		3 = 222 w/ Fin	E = EPDM		I = Stainless Steel Insert
	0.1		30" (76.2 cm)		4 = 222 w/ Flat Cap	S = Silicone		
	0.2		40" (101.6 cm)		6 = 226 w/ Flat Cap	T = Teflon® Encapsulated Viton®		
	0.45				7 = 226 w/ Fin	V = Viton®		
	0.65				16 = 213 Internal O-Ring	Z = Teflon® Encapsulated Silicone		
	0.8				28 = 222 3-tabs w/ Fin			
	1.2							

DISCLAIMER: Filtration data presented is representative of performance observed in controlled laboratory testing. It is not given as a warranty, specification or statement of fitness for use. Specific performance can vary widely depending on contaminant type, fluid properties, flow rates and environmental conditions. It is recommended that users conduct thorough qualification testing to assure the product functions as required. For additional technical support, a product Performance Guide is available upon request.

DS\_GFHNY\_190918

### Typical Applications

- Bottled Water
- Wine
- Soft Drinks
- Pharmaceutical
- Fermentation
- Endotoxin Removal

### Construction Materials

**Membrane**.....Nylon 6,6  
**Support Media**.....Polypropylene  
**End Caps**.....Polypropylene  
**Center Core**.....Polypropylene  
**Outer Support Cage**.....Polypropylene  
**O-Rings/Gaskets**.....Buna, EPDM, Silicone, Teflon® Encapsulated Viton®, Viton®, Teflon® Encapsulated Silicone

### Sanitization/Sterilization

**Filtered Hot Water**.....80°C for 30 min.  
**Steam Sterilization**.....121°C for 30 min., multiple cycles

**Chemicals:** Cartridges are compatible with most chemical sanitizing agents.

**Note:** Stainless steel insert required for all cartridges being hot water sanitized or steam sterilized.

### Dimensions

#### Length:

10 to 40 inches (25.4 to 101.6 cm) nominal

#### Outside Diameter:

2.70 inches (7.0 cm) nominal

### Operating Conditions

**Change Out ΔP (recommended)**.....35 PSID

**Temperature (max)**.....176°F (80°C)

**Differential Pressure (max)**.....50 PSID (3.4 bar) at 68°F (20°C)

### Toxicity

All polypropylene components meet the specifications for biological safety per USP Class VI – 121°C for plastics.

### Food Safety Compliance

Materials of construction comply with FDA regulations for food and beverage contact use as detailed in the US Code of Federal Regulations, 21CFR. Materials used to produce filter media and hardware are deemed safe for use in contact with foodstuffs in accordance with EU Directives 2002/72/EC, 1935/2004, and/or 10/2011.

## PSH-Series Hydrophobic Polysulfone

PSH-Series High Purity Hydrophobic Polysulfone Membrane Filter Cartridges provide a cost-effective alternative to PTFE or PVDF membrane cartridges for air, bulk gas, and tank vent applications requiring high moisture resistance. The highly asymmetric membrane pore structure provides high flow rate at low pressure drop. Constructed using high purity polypropylene hardware and support layers. PSH-Series cartridges offer outstanding performance value. Manufactured in a clean-room environment to maintain high standards of purity and cleanliness.

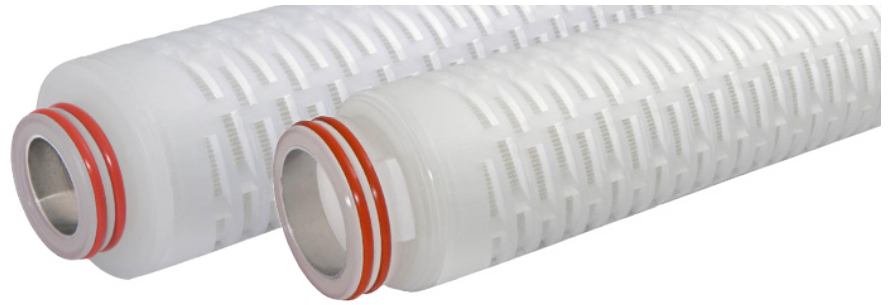

### Flow Rate vs Pressure Drop

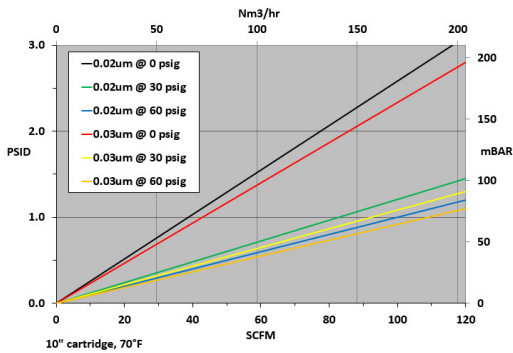

### Typical Applications

- Tank Vent
- Fermentation
- Air, Nitrogen, Other Inert Gases

### Construction Materials

**Membrane**.....Hydrophobic Polysulfone  
**Support Media**.....Polypropylene  
**End Caps**.....Polypropylene  
**Center Core**.....Polypropylene  
**Outer Support Cage**.....Polypropylene  
**O-Rings/Gaskets**.....Buna, EPDM, Silicone,  
 Teflon® Encapsulated Viton®, Viton®,  
 Teflon® Encapsulated Silicone

### Sanitization/Sterilization

**Filtered Hot Water**.....80°C for 30 min.  
**Steam Sterilization**.....121°C for 30 min.,  
 multiple cycles

**Chemicals:** Cartridges are compatible with most chemical sanitizing agents.

**Note:** Stainless steel insert option required for all cartridges being hot water sanitized or steam sterilized.

### Toxicity

All polypropylene components meet the specifications for biological safety per USP Class VI – 121°C for plastics.

### Dimensions

**Length:**  
 10 to 40 inches (25.4 to 101.6 cm) nominal  
**Outside Diameter:**  
 2.70 inches (7.0 cm) nominal

### Operating Conditions

**Change Out ΔP (recommended)**.....35 PSID  
**Temperature (max)**.....176°F (80°C)  
**Differential Pressure (max)**.....50 PSID  
 (3.4 bar) at 68°F (20°C)

### Food Safety Compliance

Materials of construction comply with FDA regulations for food and beverage contact use as detailed in the US Code of Federal Regulations, 21CFR. Materials used to produce filter media and hardware are deemed safe for use in contact with foodstuffs in accordance with EU Directives 2002/72/EC, 1935/2004, and/or 10/2011.

### Ordering Information

PSH	Rating (µ)	A	Length	C	End Cap Style	O-Rings/Gaskets	-	Adders
	0.02		10" (25.4 cm)		2 = DOE Flat Gasket	B = Buna		CS = 316SS Compression Spring
	0.03		20" (50.8 cm)		3 = 222 w/ Fin	E = EPDM		HP = Heavy Poly Core
			30" (76.2 cm)		4 = 222 w/ Flat Cap	S = Silicone		I = Stainless Steel Insert
			40" (101.6 cm)		6 = 226 w/ Flat Cap	T = Teflon® Encapsulated Viton®		
					7 = 226 w/ Fin	V = Viton®		
					16 = 213 Internal O-Ring	Z = Teflon® Encapsulated Silicone		
					28 = 222 3-tabs w/ Fin			

DISCLAIMER: Filtration data presented is representative of performance observed in controlled laboratory testing. It is not given as a warranty, specification or statement of fitness for use. Specific performance can vary widely depending on contaminant type, fluid properties, flow rates and environmental conditions. It is recommended that users conduct thorough qualification testing to assure the product functions as required. For additional technical support, a product Performance Guide is available upon request.

DS\_PSH\_190918

## GGPTFE-Series General Grade PTFE

GGPTFE-Series High Purity General Grade PTFE Filter Cartridges, with expanded polytetrafluoroethylene (PTFE) membrane, provide superior chemical resistance for a broad range of industrial applications. With retention ratings as fine as 0.1 μ (100 nanometers), consistent contaminant removal is achieved in aggressive fluids and organic solvents. In air/gas/vent applications, the single-layer PTFE membrane delivers superior hydrophobicity versus polypropylene or PVDF; offering a superior option to preclude water wetting and associated diminished flow. Manufactured in a clean-room environment to maintain high standards of purity and cleanliness.

### Flow Rate vs Pressure Drop

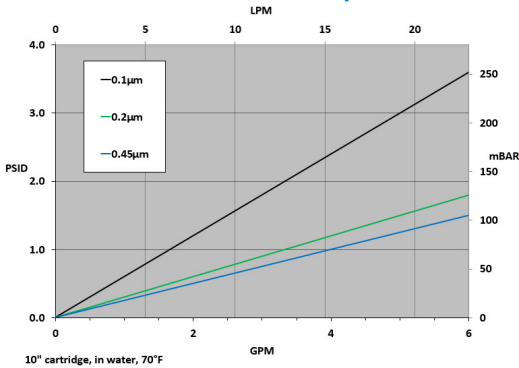

### Typical Applications

- Aggressive Fluids
- Fermentation Feed Air
- Venting
- Photoresists
- Inert gases

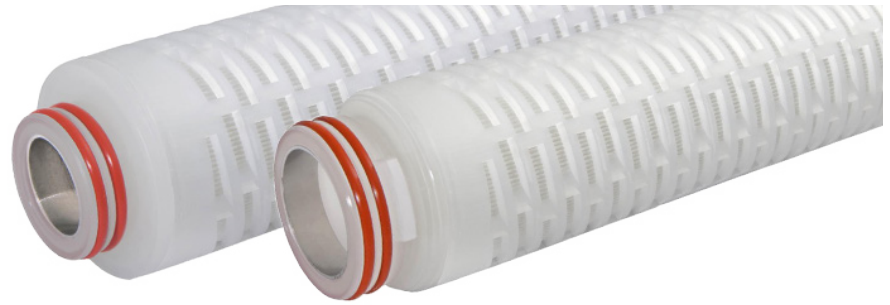

### Construction Materials

**Membrane**.....Teflon®  
**Support Media**.....Polypropylene  
**End Caps**.....Polypropylene  
**Center Core**.....Polypropylene  
**Outer Support Cage**.....Polypropylene  
**O-Rings/Gaskets**.....Buna, EPDM, Silicone,  
 Teflon® Encapsulated Viton®, Viton®,  
 Teflon® Encapsulated Silicone

### Sanitization/Sterilization

**Filtered Hot Water**.....80°C for 30 min.  
**Steam Sterilization**.....121°C for 30 min.,  
 multiple cycles

**Chemicals:** Cartridges are compatible with most chemical sanitizing agents.

**Note:** Stainless steel insert option required for all cartridges being hot water sanitized or steam sterilized.

### Toxicity

All polypropylene components meet the specifications for biological safety per USP Class VI – 121°C for plastics.

### Dimensions

**Length:**  
 10 to 40 inches (25.4 to 101.6 cm) nominal  
**Outside Diameter:**  
 2.70 inches (7.0 cm) nominal

### Operating Conditions

**Change Out ΔP (recommended)**.....35 PSID  
**Temperature (max)**.....176°F (80°C)  
**Differential Pressure (max)**.....50 PSID  
 (3.4 bar) at 68°F (20°C)

### Food Safety Compliance

Materials of construction comply with FDA regulations for food and beverage contact use as detailed in the US Code of Federal Regulations, 21CFR. Materials used to produce filter media and hardware are deemed safe for use in contact with foodstuffs in accordance with EU Directives 2002/72/EC, 1935/2004, and/or 10/2011.

### Ordering Information

GGPTFE	Rating (μ)	A	Length	C	End Cap Style	O-Rings/Gaskets	-	Adders
	0.1		10" (25.4 cm)		2 = DOE Flat Gasket	B = Buna		CS = 316SS Compression Spring
	0.2		20" (50.8 cm)		3 = 222 w/ Fin	E = EPDM		I = Stainless Steel Insert
	0.45		30" (76.2 cm)		4 = 222 w/ Flat Cap	S = Silicone		
			40" (101.6 cm)		6 = 226 w/ Flat Cap	T = Teflon® Encapsulated Viton®		
					7 = 226 w/ Fin	V = Viton®		
					16 = 213 Internal O-Ring	Z = Teflon® Encapsulated Silicone		
					28 = 222 3-tabs w/ Fin			

DISCLAIMER: Filtration data presented is representative of performance observed in controlled laboratory testing. It is not given as a warranty, specification or statement of fitness for use. Specific performance can vary widely depending on contaminant type, fluid properties, flow rates and environmental conditions. It is recommended that users conduct thorough qualification testing to assure the product functions as required. For additional technical support, a product Performance Guide is available upon request.

DS\_GGPTFE\_190918



## EPTFE-Series Electronics Grade PTFE

EPTFE-Series High Purity Electronics Grade PTFE Filter Cartridges, with expanded polytetrafluoroethylene (PTFE) membrane, provide superior chemical resistance in high-purity microelectronics applications. With retention ratings as fine as 0.02 micron (20 nanometers), consistent contaminant removal is achieved in aggressive fluids and organic solvents. In air and gas applications, the single-layer PTFE membrane delivers superior hydrophobicity versus polypropylene or PVDF, offering a superior option to preclude water wetting and associated diminished flow. Each element is integrity tested to assure optimal performance. Manufactured in a clean-room environment to maintain high standards of purity and cleanliness.

### Flow Rate vs Pressure Drop

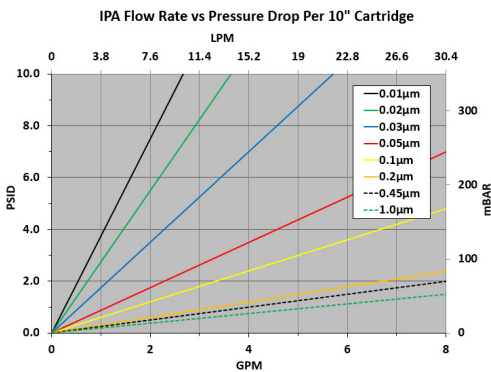

### Typical Applications

- Solvent filtration
- Etching bath solutions
- High purity rinse water
- Photochemical solutions
- Bulk chemical delivery
- Ultrapure electronics - grade gases

### Construction Materials

**Membrane**.....PTFE  
**Support Layers**.....Polypropylene  
**Cage/Core/Adapters**.....Polypropylene  
**Seals**.....Buna, EPDM, Silicone, Teflon® Encapsulated Viton®, Viton®

#### Note:

Cartridges are available with wet-pack option (60/40 IPA/DI water solution) to eliminate the need to wet-out in the environment.

### Dimensions

#### Length:

10 to 40 inches (25.4 to 101.6 cm) nominal

#### Outside Diameter:

2.70 inches (7.0 cm) nominal

### Operating Conditions

**Change Out ΔP (recommended)**.....35 PSID

**Temperature (max)**.....176°F (80°C)

**Differential Pressure (max)**.....50 PSID  
 (3.4 bar) at 68°F (20°C)

### Food Safety Compliance

Materials of construction comply with FDA regulations for food and beverage contact use as detailed in the US Code of Federal Regulations, 21CFR. Materials used to produce filter media and hardware are deemed safe for use in contact with foodstuffs in accordance with EU Directives 2002/72/EC, 1935/2004, and/or 10/2011.

### Ordering Information

EPTFE	Rating (µ)	A	Length	C	End Cap Style	O-Rings/Gaskets	Options
	0.02 (20 nm)		10" (25.4 cm)		2 = DOE Flat Gasket	B = Buna	I = Stainless Steel Insert
	0.03 (30 nm)		20" (50.8 cm)		3 = 222 w/ Fin	E = EPDM	W = Wet-Packed
	0.05 (50 nm)		30" (76.2 cm)		4 = 222 w/ Flat Cap	S = Silicone	
	0.1		40" (101.6 cm)		6 = 226 w/ Flat Cap	T = Teflon® Encapsulated Viton®	
	0.2				7 = 226 w/ Fin	V = Viton®	
	0.45				28 = 222 3-tabs w/ Fin		
	1.0						

DISCLAIMER: Filtration data presented is representative of performance observed in controlled laboratory testing. It is not given as a warranty, specification or statement of fitness for use. Specific performance can vary widely depending on contaminant type, fluid properties, flow rates and environmental conditions. It is recommended that users conduct thorough qualification testing to assure the product functions as required. For additional technical support, a product Performance Guide is available upon request.

DS\_EPTFE\_190918

## BRPTFE-Series Bio-Burden Reduction Grade PTFE

BRPTFE-Series High Purity Bio-Reduction Grade PTFE Filter Cartridges, with expanded polytetrafluoroethylene (PTFE) membrane, provide reliable high-LRV reduction of micro-organisms in bio-process applications where the high cost of a fully-validated pharmaceutical-grade cartridge is not required. Whether it's fermentation feed air, compressed gas, or a process venting application, the BRPTFE offers a high-flow, high-capacity membrane filter with exceptional hydrophobicity. The superior flow rate allows for economical costs of system design & operation. Proven 7.4 LRV retention of aerosolized bacteriophage provides reliable bioburden reduction and prevention of process contamination. Tolerates multiple sterilization cycles by autoclave or *in-situ* steaming. 100% integrity tested in production. Manufactured in a clean-room environment to maintain high standards of purity and cleanliness.

### Flow Rate vs Pressure Drop

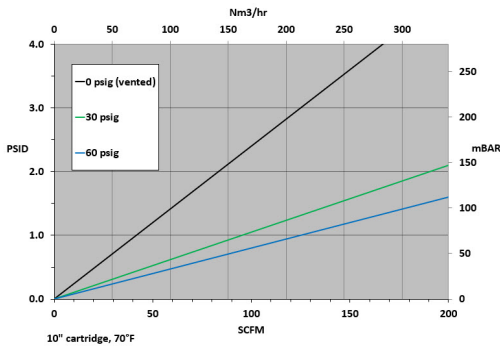

### Typical Applications

- Fermentation feed air
- Compressed air & gases
- Process venting

### Ordering Information

BRPTFE	Rating (μ)	A	Length	C	End Cap Style	O-Rings/Gaskets	-	Adders
	0.2		10" (25.4 cm)		2 = DOE Flat Gasket	B = Buna		CS = 316SS Compression Spring
			20" (50.8 cm)		3 = 222 w/ Fin	E = EPDM		HT = High Temperature
			30" (76.2 cm)		4 = 222 w/ Flat Cap	S = Silicone		
			40" (101.6 cm)		6 = 226 w/ Flat Cap	T = Teflon® Encapsulated Viton®		
					7 = 226 w/ Fin	V = Viton®		
					16 = 213 Internal O-Ring	Z = Teflon® Encapsulated Silicone		
					28 = 222 3-tabs w/ Fin			

DISCLAIMER: Filtration data presented is representative of performance observed in controlled laboratory testing. It is not given as a warranty, specification or statement of fitness for use. Specific performance can vary widely depending on contaminant type, fluid properties, flow rates and environmental conditions. It is recommended that users conduct thorough qualification testing to assure the product functions as required. For additional technical support, a product Performance Guide is available upon request.

DS\_BRPTFE\_190918



### Construction Materials

**Membrane**.....PTFE  
**Support Media**.....Polypropylene  
**End Caps**.....Polypropylene  
**Center Core**.....Polypropylene  
**Outer Support Cage**.....Polypropylene  
**O-Rings/Gaskets**.....Buna, EPDM, Silicone, Viton®, Teflon® Encapsulated Silicone

**High Temperature "HT"** construction option features stainless steel core and polyester support layers.

### Sanitization/Sterilization

**Filtered Hot Water**.....80°C for 30 min.  
**Steam Sterilization**.....121°C for 30 min., multiple cycles

#### Note:

Cartridge O-ring adapters feature integral reinforcement to assure no deformation under repeated steam sterilization cycles.

**Chemicals:** Cartridges are compatible with most chemical sanitizing agents.

### Dimensions

**Length:** 10 to 40 inches (25.4 to 101.6 cm) nominal  
**Outside Diameter:** 2.70 inches (7.0 cm) nominal

### Operating Conditions

**Change Out ΔP (recommended)**.....35 PSID  
**Temperature (max)**.....176°F (80°C)  
**Differential Pressure (max)**.....50 PSID (3.4 bar) at 68°F (20°C)

### Toxicity

All polypropylene components meet the specifications for biological safety per USP Class VI – 121°C for plastics.

### Food Safety Compliance

Materials of construction comply with FDA regulations for food and beverage contact use as detailed in the US Code of Federal Regulations, 21CFR. Materials used to produce filter media and hardware are deemed safe for use in contact with foodstuffs in accordance with EU Directives 2002/72/EC, 1935/2004, and/or 10/2011.

## PPTFE-Series Pharmaceutical Grade PTFE

PPTFE-Series High Purity Pharmaceutical Grade PTFE Filter Cartridges, with expanded polytetrafluoroethylene (PTFE) membrane, provide optimized filtration performance in sterile air/gas filtration and venting applications. The single layer PTFE membrane, with over twice the hydrophobicity of polypropylene or PVDF, is the best choice to prevent water intrusion and resulting microbial growth. Each PPTFE cartridge is integrity tested during manufacturing and is supported by a validation guide for regulatory compliance. PPTFE elements are fully validated as sterilizing grade filters in liquids in accordance with HIMA and ASTM F838-05 guidelines and in gases through full retention of the MS2 phage in an aerosol challenge. Manufactured in a clean-room environment to maintain high standards of purity and cleanliness.



### Flow Rate vs Pressure Drop

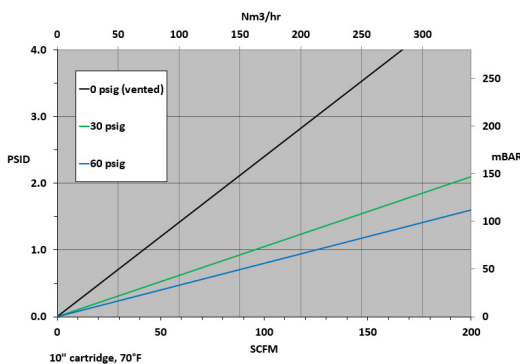

### Typical Applications

- Sterile gas filtration of fermentor inlets
- Off-gassing downstream of fermentors and bioreactors
- Autoclave vent filters
- WFI tank vents
- Sterile air supply for service gases (i.e. filling lines in blow-fill-seal systems)

### Construction Materials

**Membrane**.....PTFE  
**Prefiltration Media**.....Polypropylene  
**Support Layers**.....Polypropylene  
**Cage/Core/Adapters**.....Polypropylene  
**Seals**.....Buna, EPDM, Silicone, Viton®, Teflon® Encapsulated Silicone

**Note:** O-ring adapters include integral reinforcement that will not deform with repeated steam sterilization or hot water sanitation cycles.

### Toxicity

All polypropylene components meet the specifications for biological safety per USP Class VI – 121°C for plastics.

### Dimensions

#### Length:

5 to 40 inches (12.7 to 101.6 cm) nominal

#### Outside Diameter:

2.78 inches (7.06 cm) nominal

### Sanitization/Sterilization

**Steam Sterilization**.....134°C, 30 min., max. 7 PSID, 150 cycles

**Hot Water**.....85°- 95°C, 30 min., max. 7 PSID

### Operating Conditions

**Change Out ΔP (recommended)**.....35 PSID

**Temperature (max)**.....248°F (120°C)

**Differential Pressure (max)**......72 PSID (5.0 bar) at 68°F (20°C)

### Food Safety Compliance

Materials of construction comply with FDA regulations for food and beverage contact use as detailed in the US Code of Federal Regulations, 21CFR. Materials used to produce filter media and hardware are deemed safe for use in contact with foodstuffs in accordance with EU Directives 2002/72/EC, 1935/2004, and/or 10/2011.

### Ordering Information

PPTFE	Rating (μ)	A	Length	C	End Cap Style	O-Rings/Gaskets
	0.2		5" (12.7 cm)		2 = DOE Flat Gasket	B = Buna
			10" (25.4 cm)		3 = 222 w/ Fin	E = EPDM
			20" (50.8 cm)		4 = 222 w/ Flat Cap	S = Silicone
			30" (76.2 cm)		6 = 226 w/ Flat Cap	T = Teflon® Encapsulated Viton®
			40" (101.6 cm)		7 = 226 w/ Fin	V = Viton®
					28 = 222 3-tabs w/ Fin	Z = Teflon® Encapsulated Silicone

DISCLAIMER: Filtration data presented is representative of performance observed in controlled laboratory testing. It is not given as a warranty, specification or statement of fitness for use. Specific performance can vary widely depending on contaminant type, fluid properties, flow rates and environmental conditions. It is recommended that users conduct thorough qualification testing to assure the product functions as required. For additional technical support, a product Validation Guide is available upon request.

DS\_PPTFE\_190918





## GPFA-Series Pleated All-Fluoropolymer PTFE/PFA

GPFA-Series High Purity All-Fluoropolymer Filter Cartridges provide superior chemical compatibility, temperature range, and ultra-low extractables for the most demanding needs of the micro-electronics industry. Ideal for aggressive “wet-etch and clean” applications. The PTFE membrane offers high flowrates at low pressure drop, while the PFA-440HP hardware exhibits superior chemical resistance and high temperature tolerance. Minimized ionic and TOC extractables are attained through a specialized UPW flush process. Wet-packing option is available for ease of wetting in aqueous applications. Available in the full range of micron ratings to suit all applications.

### Flow Rate vs Pressure Drop

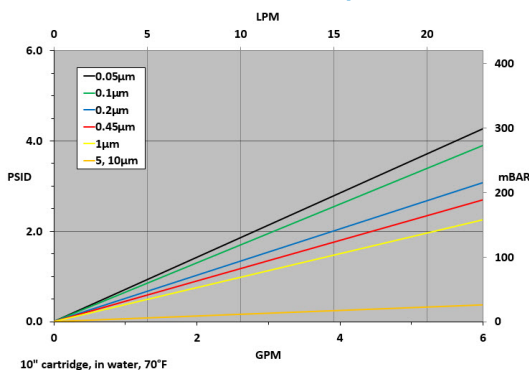

### Typical Applications

#### Highly Reactive Chemicals

- Acetic Acid (10%)
- Hydrofluoric Acid (50%)
- Hydrogen Peroxide (30%)
- Nitric Acid (conc.)
- Phosphoric Acid (conc.)
- Sulfuric Acid (cavonc.)
- Ammonium Hydroxide (conc.)
- Potassium Hydroxide (conc.)
- Sodium Hydroxide (conc.)
- TMAH (5%)
- Aqua Regia (HNO<sub>3</sub>:HCl)
- BOE; NH<sub>4</sub>F:HF
- Mixed Acid Etch
- ChromPhos Etch
- Piranha Etch

### Dimensions

#### Length:

5 to 40 inches (12.7 to 101.6 cm)  
nominal

#### Outside Diameter:

2.68 inches (6.8 cm) nominal

### Construction Materials

**Filtration Media**.....PTFE  
**Support Media**.....PFA  
**End Caps**.....PFA440HP  
**Center Core**.....PFA440HP  
**Outer Support Cage**.....PFA440HP  
**O-Rings**.....Teflon® Encapsulated Viton®

### Operating Conditions

**Change Out ΔP (recommended)**.....35 PSID  
**Temperature (max)**.....365°F (185°C)  
**Differential Pressure (max)**.....60 PSID  
 (4.1 bar) at 68°F (20°C)

### Cleanliness

The Semiconductor Rinse (SR) option delivers extraordinary product cleanliness at these typical levels.

**Metals Extractable:**..... < 20 ppb total

**Particulate Extractable:**..... ≤ 2 counts/ml at ≥ 0.2µ  
 ≤ 1 count/ml at ≥ 1.0µ

**TOC Extractable:**.....below detection limits

### Ordering Information

GPFA	Rating (µ)	A	Length	C	End Cap Style	O-Rings	Options
	0.05		5" (12.7 cm)		3 = 222 w/Fin	T = Teflon® Encapsulated Viton®	SR = Semiconductor Rinse
	0.1		10" (25.4 cm)		4 = 222 w/Flat Cap		W = Wet Packed
	0.2		20" (50.8 cm)		6 = 226 w/Flat Cap		
	0.45		30" (76.2 cm)		7 = 226 w/Fin		
	1.0		40" (101.6 cm)		24 = 222 w/Hat Cap		
	5.0						
	10.0						

DISCLAIMER: Filtration data presented is representative of performance observed in controlled laboratory testing. It is not given as a warranty, specification or statement of fitness for use. Specific performance can vary widely depending on contaminant type, fluid properties, flow rates and environmental conditions. It is recommended that users conduct thorough qualification testing to assure the product functions as required.

DS\_GPFA\_191126

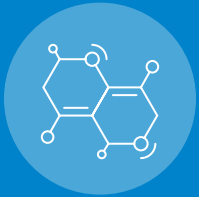

## HIGH FLOW CARTRIDGES

Multi-layer, fiber-based media provides true depth-loading for high efficiency removal at low micron ratings. The larger diameter pleated design offers extremely high surface area, allowing for outstanding loading at high flow rates per single cartridge. This reduces the number of required cartridges, thus reducing the total filtration costs.

## HFB-Series High Flow Pleated

HFB-Series High Flow Pleated Filter Cartridges seal into most standard bag filter vessels. These cartridges deliver high efficiencies, flow rates, and loading capacities at extremely low initial pressure drops. Due to the inside-to-outside flow design, all contaminants are captured on the inside of the element, avoiding potential contamination of filtered product during change-out. Utilizing polypropylene or microglass medias along with polypropylene hardware, the HFB series offers broad chemical compatibility. With up to 48.5 ft<sup>2</sup> of media, the HFB series offers an exceptional value.

### Dimensions

#### Length:

12 inches (#1-size)

24 inches (#2-size)

#### Outside Diameter:

### Flow Rate vs Pressure Drop

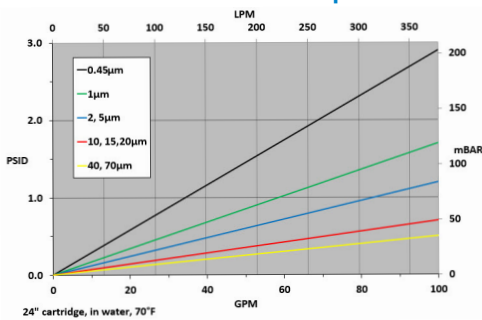

### Typical Applications

- Process Water
- Deionized Water
- R.O. Membrane Pre-Filtration
- Food & Beverage
- Cosmetics
- Fine Chemicals
- Produced Water
- Waste Water
- Amines

### Construction Materials

**Filtration Media**..... Polypropylene or Microglass

**Support Media**..... Polypropylene or Polyester

**End Caps**..... Polypropylene

**Center Core**..... Polypropylene

**Outer Netting/Wrap**..... Polypropylene

### Operating Conditions

**Change Out ΔP (recommended)**.....25 PSID

**Temperature (max)**.....160°F (71°C)

**Differential Pressure (max)**.....50 PSID  
(3.4 bar) at 68°F (20°C)

### Toxicity

All polypropylene components meet the specifications for biological safety per USP Class VI-121°C for plastics.



### Food Safety Compliance

Materials of construction comply with FDA regulations for food and beverage contact use as detailed in the US Code of Federal Regulations, 21CFR. Materials used to produce filter media and hardware are deemed safe for use in contact with foodstuffs in accordance with EU Directives 2002/72/EC, 1935/2004, and/or 10/2011.

### Ordering Information

HFB	Material	Rating (μ)	Retention	Size	Flange Style	Hardware	O-Rings (For B & D Flange Only)
	PP = Polypropylene	0.45	A = Absolute	1 = #1-size	A = Global Filter	P = Polypropylene	B = Buna
	FG = Microglass	1.0	N = Nominal	2 = #2-size	B = Pentair, Rosedale®		E = EPDM
		2.0			D = FSI® & Eaton® (OTT)		S = Silicone
		5.0					V = Viton®
		10.0					
		15.0					
		20.0					
		40.0					
		70.0					

DISCLAIMER: Filtration data presented is representative of performance observed in controlled laboratory testing. It is not given as a warranty, specification or statement of fitness for use. Specific performance can vary widely depending on contaminant type, fluid properties, flow rates and environmental conditions. It is recommended that users conduct thorough qualification testing to assure the product functions as required.

DS\_HFB\_190918

## EHF3-Series High Flow Pleated

EHF3-Series High Flow Pleated Filter Cartridges are designed to address the need for critical filtration in high flow applications. Large diameter, high surface area filters dramatically reduce maintenance and production downtime. EHF3 cartridges are a direct replacement for the 3M/Cuno™ High Flow series cartridges. The EHF3 Series cartridges are available in both polypropylene and microglass media in a wide variety of micron ratings. This filter utilizes polypropylene hardware to provide a robust design. Both the polypropylene and microglass media provide broad chemical compatibility. Filtration efficiencies exceed 99%.



### Flow Rate vs Pressure Drop

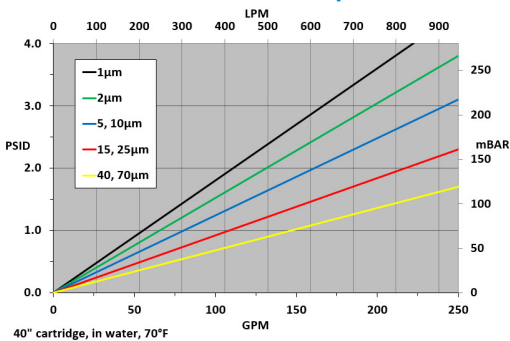

### Dimensions

#### Length:

40, 60 inches

#### Outside Diameter:

6.5 inches

#### Inside Diameter:

3.0 inches

### Construction Materials

**Filtration Media**.....Polypropylene or Microglass  
**Support Media**.....Polypropylene  
**End Caps**.....Glass-reinforced Nylon  
**Center Core**.....Polypropylene  
**Outer Support Cage**.....Polypropylene  
**O-Rings/Gaskets**.....Buna, EPDM, Silicone, Viton®

### Operating Conditions

**Change Out ΔP (recommended)**.....35 PSID  
**Polypropylene Temperature (max)**....160°F (71°C)  
**Microglass Temperature (max)**.....200°F (93°C)  
**Differential Pressure (max)**.....60 PSID (4.1 bar) at 68°F (20°C)

### Sanitization/Sterilization

**Filtered Hot Water**.....80°C for 30 min.

### Food Safety Compliance

Materials of construction comply with FDA regulations for food and beverage contact use as detailed in the US Code of Federal Regulations, 21CFR. Materials used to produce filter media and hardware are deemed safe for use in contact with foodstuffs in accordance with EU Directives 2002/72/EC, 1935/2004, and/or 10/2011.

### Ordering Information

EHF3	Material	Rating (µm)	Retention	Length	O-Rings
	PP = Polypropylene	1.0	A = Absolute	40" (101.6 cm)	B = Buna
	FG = Microglass	2.0	N = Nominal	60" (152.4 cm)	E = EPDM
		5.0			S = Silicone
		10.0			V = Viton®
		15.0			
		25.0			
		40.0			
		70.0			

DISCLAIMER: Filtration data presented is representative of performance observed in controlled laboratory testing. It is not given as a warranty, specification or statement of fitness for use. Specific performance can vary widely depending on contaminant type, fluid properties, flow rates and environmental conditions. It is recommended that users conduct thorough qualification testing to assure the product functions as required.

DS\_EHF3\_191001



## HF/HF3-Series High Flow Pleated

HF-Series High Flow Polypropylene and Micro-glass Filter Cartridges address your need for absolute rated filter cartridges in high flowrate applications. HF-Series cartridges are designed for use as a direct replacement to the Pall® Ultipleat® High Flow and 3M 740™ series elements. Filtration efficiencies exceed 99%.

### Flow Rate vs Pressure Drop

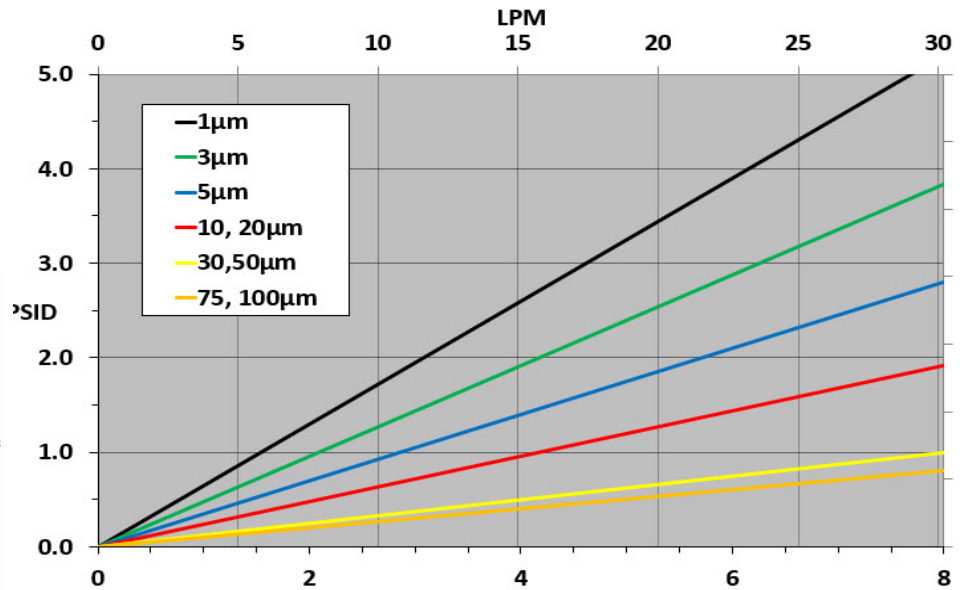
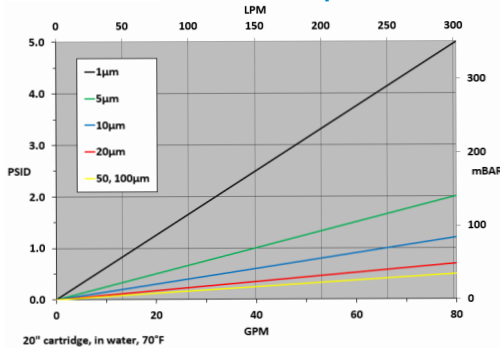

### Construction Materials

<b>Filtration Media</b> .....	Polypropylene or Microglass
<b>Support Media</b> .....	Polypropylene
<b>End Caps</b> .....	Polypropylene
<b>Center Core</b> .....	Polypropylene
<b>Outer Support Cage</b> .....	Polypropylene
<b>O-Rings/Gaskets</b> .....	Buna, EPDM, Silicone, Viton®

### Operating Conditions

<b>Change Out <math>\Delta P</math> (recommended)</b> .....	.35 PSID
<b>Polypropylene Temperature (max)</b> .....	160°F (71°C)
<b>Microglass Temperature (max)</b> .....	200°F (93°C)
<b>Differential Pressure (max)</b> .....	.60 PSID (4.1 bar) at 68°F (20°C)

### Food Safety Compliance

Materials of construction comply with FDA regulations for food and beverage contact use as detailed in the US Code of Federal Regulations, 21CFR. Materials used to produce filter media and hardware are deemed safe for use in contact with foodstuffs in accordance with EU Directives 2002/72/EC, 1935/2004, and/or 10/2011.

### Dimensions

#### Length:

HF - 20, 40, 60 inches

HF3 - 39 inches

#### Outside Diameter:

6.25 inches

### Ordering Information

Type	Material	Rating ( $\mu$ )	A	Length	O-Rings
<b>HF</b>	PP = Polypropylene	0.45	A= Absolute	20" = HF (50.8 cm)	B = Buna
	Retrofits	1.0		39" = HF3 (99.1 cm)	E = EPDM
	Pall® HF	5.0		40" = HF (101.6 cm)	S = Silicone
<b>HF3</b>		10.0		60" = HF (152.4 cm)	V = Viton®
		20.0			
	Retrofits	50.0			
	3M™ - 740	100.0			

Pall® is a registered trademark of Pall® Corporation

DS\_HF\_190918



## DEPTH CARTRIDGES

Due to their gradient density depth construction, our depth cartridge products are an economical option for the removal of both fine and coarse deformable and non-deformable contaminants. Ideal for use as a prefilter, protecting costly downstream pleated cartridges and equipment, or as a final filter in a wide variety of industries and applications.

## GPB-Series Bi-Component Polyolefin

GPB-Series Bi-Component Polyolefin Filter Cartridges feature thermally bonded co-extruded polyolefin fibers manufactured in a unique and proprietary process. The result is fiber-to-fiber point bonds forming a rigid, fixed-matrix pore structure. The performance benefit of this construction is a sharpened retention size cut-off. Furthermore, the enhanced matrix rigidity provides greater tolerance to differential pressures. This unique feature also prevents changes in fiber matrix throughout the life of the filter. Consistent precise filtration acts to prevent against contaminant unloading. GPB-series filter cartridges are free of additives, wetting agents, binders and silicone.

### Flow Rate vs Pressure Drop

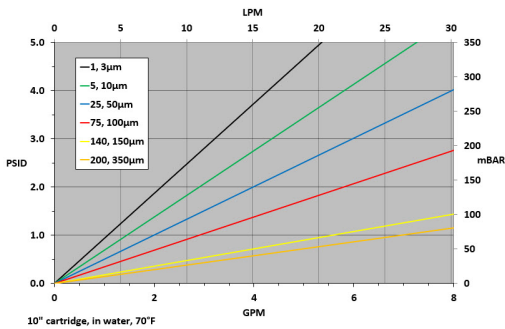

### Typical Applications

- Paints and Coatings
- High-purity Inks
- Resins
- R.O. Pre-Filtration
- Food and Beverage
- Particle Classification

### Construction Materials

**Filtration Media**..... Polyolefin  
**End Caps**..... Polypropylene

### Dimensions (Nominal)

**Length:**  
 9.75 to 40 inches (24.8 to 102 cm)  
**Outside Diameter:**  
 2.6 inches (6.6 cm)  
**Inside Diameter:**  
 1.1 inch (2.8 cm)

### Operating Conditions

**Change Out ΔP (recommended)**.....35 PSID  
**Temperature (max)**.....176°F (80°C)  
**Differential Pressure (max)**.....80 PSID  
 (5.5 bar) at 68°F (20°C)

### Food Safety Compliance

Materials of construction comply with FDA regulations for food and beverage contact use as detailed in the US Code of Federal Regulations, 21CFR. Materials used to produce filter media and hardware are deemed safe for use in contact with foodstuffs in accordance with EU Directives 2002/72/EC, 1935/2004, and/or 10/2011.

## Ordering Information

GPB		-	Length	-	End Cap Style	O-Rings/Gaskets
Polyolefin	1 = Cuno "A"		9.75" (24.76 cm)		Blank = None	Blank = None
	3 = Cuno "B"		10" (25.4 cm)		2 = DOE Flat Gasket	B = Buna
	5 = Cuno "C"		19.5" (49.53 cm)		3 = 222 w/Fin	E = EPDM
	10 = Cuno "D"		20" (50.8 cm)		4 = 222 w/Flat Cap	P = Polyfoam
	25 = Cuno "E"		29.25" (74.29 cm)		5 = 222 w/Spring	S = Silicone
	50 = Cuno "G"		30" (76.2 cm)		6 = 226 w/Flat Cap	V = Viton®
	75 = Cuno "L"		39" (99.1 cm)		7 = 226 w/Fin	
	100 = Cuno "Q"		40" (101.6 cm)		8 = 226 w/Spring	
	140 = Cuno "V"				9 = SOE w/ Spring	
	150 = Cuno "W"				10 = DOE w/ Core Extender	
	200 = Cuno "X"					
	350 = Cuno "Y"					

DISCLAIMER: Filtration data presented is representative of performance observed in controlled laboratory testing. It is not given as a warranty, specification or statement of fitness for use. Specific performance can vary widely depending on contaminant type, fluid properties, flow rates and environmental conditions. It is recommended that users conduct thorough qualification testing to assure the product functions as required.

DS\_GPB\_190918

## GWTB-Series Water Grade Meltblown Polypropylene

### GWTB-Series Water Grade Meltblown

#### Polypropylene Filter Cartridges:

- A gradient density structure provides for low pressure drop and high dirt holding capacity.
- All polypropylene construction presents excellent compatibility with a wide range of chemicals.
- Resists contaminant unloading, even at elevated differential pressures.
- All end configurations available (glued or thermally-bonded).
- Easy cartridge incineration and disposal.
- Free of additives, wetting agents, binders and silicone.



### Flow Rate vs Pressure Drop

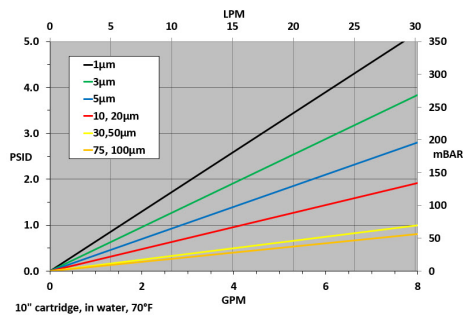

### Construction Materials

**Filtration Media**..... Polypropylene  
**End Caps**..... Polypropylene  
**O-Rings/Gaskets**..... Buna, EPDM, Polyfoam, Silicone, Viton®

### Operating Conditions

**Change Out ΔP (recommended)**.....35 PSID  
**Temperature (max)**.....140°F (60°C)  
**Differential Pressure (max)**.....50 PSID (3.4 bar) at 68°F (20°C)

### Dimensions (Nominal)

**Length**.....9.75 to 40 inches (24.8 to 102 cm)  
**Outside Diameter**.....2.5 inches (6.4 cm)  
**Inside Diameter**.....1.06 inches (2.69 cm)

### Food Safety Compliance

Materials of construction comply with FDA regulations for food and beverage contact use as detailed in the US Code of Federal Regulations, 21CFR. Materials used to produce filter media and hardware are deemed safe for use in contact with foodstuffs in accordance with EU Directives 2002/72/EC, 1935/2004, and/or 10/2011.

### Performance Specifications

**Micron Ratings:**  
 1, 3, 5, 10, 20, 30, 50, 75, 100  
**Efficiencies:**  
 Water Grade = 80%



NSF Certification applies for use only with drinking water. Only products bearing the NSF Mark on the product, product packaging, and/or documentation shipped with the product are Certified. Product options denoted with asterisk (\*) are not included in the Certification.

### Ordering Information

GWTB	Rating (µ)	A	Length	-	End Cap Style	O-Rings/Gaskets	-	Adders
Water Grade	1	A = 2.5" OD	9.75" (24.76cm)		Blank = None	Blank = None		Blank = Glued or None
	3		9.875" (25.08 cm)		2 = DOE Flat Gasket	B = Buna		CS = 316SS Compression Spring (TB ONLY)
	5		10" (25.4 cm)		3 = 222 w/Fin	E = EPDM		PC = Polypropylene Core
	10		19.5" (49.53 cm)		4 = 222 w/Flat Cap	P = Polyfoam (Gaskets) *		TB = Thermally-Bonded
	20		20" (50.8 cm)		5 = 222 w/Spring	S = Silicone		
	30		29.25" (74.29 cm)		6 = 226 w/Flat Cap	V = Viton®*		
	50		29.5" (74.93 cm)		7 = 226 w/Fin			
	75		30" (76.2 cm)		8 = 226 w/Spring			
	100		39" (99.1 cm)		9 = SOE w/ Spring			
			40" (101.6 cm)		10 = DOE w/Core Extender			
					20 = SOE PP Ext. w/Spring			

DISCLAIMER: Filtration data presented is representative of performance observed in controlled laboratory testing. It is not given as a warranty, specification or statement of fitness for use. Specific performance can vary widely depending on contaminant type, fluid properties, flow rates and environmental conditions. It is recommended that users conduct thorough qualification testing to assure the product functions as required. For additional technical support, a product Performance Guide is available upon request.

DS\_GWTB\_191216



## GWTB BB-Series Water Grade Meltblown Polypropylene

GWTB BB-Series Water Grade Meltblown Polypropylene Filter Cartridges:

- A gradient density structure provides for low pressure drop and high dirt holding capacity.
- All polypropylene construction presents excellent compatibility with a wide range of chemicals.
- Resists contaminant unloading, even at elevated differential pressures.
- Easy cartridge incineration and disposal.
- Free of additives, wetting agents, binders and silicone.



### Flow Rate vs Pressure Drop

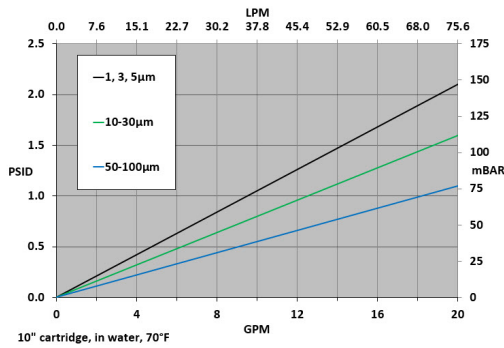

NSF Certification applies for use only with drinking water. Only products bearing the NSF Mark on the product, product packaging, and/or documentation shipped with the product are Certified. Product options denoted with asterisk (\*) are not included in the Certification.

### Construction Materials

Filtration Media..... Polypropylene

### Dimensions

Length..... 10 & 20 inches  
 Outside Diameter..... 4.5 inches  
 Inside Diameter..... 1.06 inches (2.69 cm)

### Cross - Reference

**Pentek®:**  
 DGD2501 = GWTB1  
 DGD5005 = GWTB5  
 DGD7525 = GWTB25

**Suez/GE®:**  
 LD01 = GWTB1  
 LD05 = GWTB5  
 LD10 = GWTB10  
 LD20 = GWTB20  
 LD30 = GWTB30  
 LD50 = GWTB50

### Performance Specifications

**Micron Ratings:**  
 1, 3, 5, 10, 20, 25, 30, 50, 75, 100

**Efficiencies: 80%**

### Operating Conditions

**Change Out ΔP (recommended).....**35 PSID  
**Temperature (max).....**140°F (60°C)  
**Differential Pressure (max).....**50 PSID  
 (3.4 bar) at 68°F (20°C)

### Food Safety Compliance

Materials of construction comply with FDA regulations for food and beverage contact use as detailed in the US Code of Federal Regulations, 21CFR. Materials used to produce filter media and hardware are deemed safe for use in contact with foodstuffs in accordance with EU Directives 2002/72/EC, 1935/2004, and/or 10/2011.

### Ordering Information

GWTB	Rating (µ)	BB	Length
Water Grade	1	BB = 4.5" OD	10" (25.4 cm)
	3		20" (50.8 cm)
	5		
	10		
	20		
	25		
	30		
	50		
	75		
	100		

DISCLAIMER: Filtration data presented is representative of performance observed in controlled laboratory testing. It is not given as a warranty, specification or statement of fitness for use. Specific performance can vary widely depending on contaminant type, fluid properties, flow rates and environmental conditions. It is recommended that users conduct thorough qualification testing to assure the product functions as required. For additional technical support, a product Performance Guide is available upon request.

DS\_GWTB BB\_190918

## GCTB-Series High Performance Grade Meltblown Polypropylene

GCTB-Series High Performance Grade Meltblown Polypropylene Filter Cartridges:

- Precision process control of fiber diameter and layer density tunes the media to achieve targeted retention efficiency and ensure consistent performance.
- All polypropylene construction presents excellent compatibility with a wide range of chemicals.
- Resists contaminant unloading, even at elevated differential pressures.
- All end configurations available (glued or thermally-bonded).
- Easy cartridge incineration and disposal.
- Free of additives, wetting agents, binders and silicone.



### Construction Materials

**Filtration Media**..... Polypropylene  
**End Caps**..... Polypropylene  
**O-Rings/Gaskets**..... Buna, EPDM, Polyfoam, Silicone, Viton®

### Operating Conditions

**Change Out ΔP (recommended)**.....35 PSID  
**Temperature (max)**.....140°F (60°C)  
**Differential Pressure (max)**.....50 PSID (3.4 bar) at 68°F (20°C)

### Flow Rate vs Pressure Drop

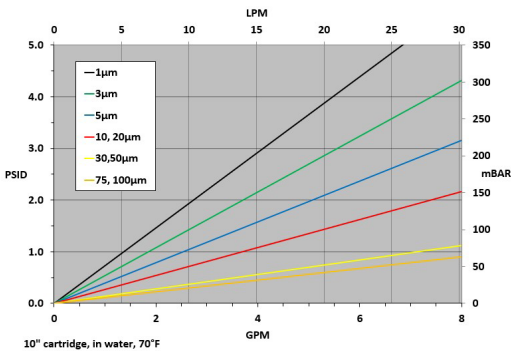

### Dimensions (Nominal)

**Length**.....9.75 to 40 inches (24.8 to 102 cm)  
**Outside Diameter**.....2.5 inches (6.4 cm)  
**Inside Diameter**.....1.06 inches (2.69 cm)

### Performance Specifications

**Micron Ratings:**  
 1, 3, 5, 10, 20, 30, 50, 75, 100  
**Efficiencies:**  
 High Performance Grade = 90%

### Food Safety Compliance

Materials of construction comply with FDA regulations for food and beverage contact use as detailed in the US Code of Federal Regulations, 21CFR. Materials used to produce filter media and hardware are deemed safe for use in contact with foodstuffs in accordance with EU Directives 2002/72/EC, 1935/2004, and/or 10/2011.



NSF Certification applies for use only with drinking water. Only products bearing the NSF Mark on the product, product packaging, and/or documentation shipped with the product are Certified. Product options denoted with asterisk (\*) are not included in the Certification.

### Ordering Information

GCTB	Rating (μ)	A	Length	-	End Cap Style	O-Rings/Gaskets	-	Adders
High Performance Grade	1		9.75" (24.76cm)		Blank = None	Blank = None		Blank = Glued or None
	3		9.875" (25.08 cm)		2 = DOE Flat Gasket	B = Buna		CS = 316SS Compression Spring (TB ONLY)
	5		10" (25.4 cm)		3 = 222 w/Fin	E = EPDM		PC = Polypropylene Core
	10		19.5" (49.53 cm)		4 = 222 w/Flat Cap	P = Polyfoam (Gaskets) *		TB = Thermally-Bonded
	20		20" (50.8 cm)		5 = 222 w/Spring	S = Silicone		
	30		29.25" (74.29 cm)		6 = 226 w/Flat Cap	V = Viton® *		
	50		29.5" (74.93 cm)		7 = 226 w/Fin			
	75		30" (76.2 cm)		8 = 226 w/Spring			
	100		39" (99.1 cm)		9 = SOE w/Spring			
			40" (101.6 cm)		10 = DOE w/ PP Core Ext.			
					20 = DOE PP Ext. w/Spring			

DISCLAIMER: Filtration data presented is representative of performance observed in controlled laboratory testing. It is not given as a warranty, specification or statement of fitness for use. Specific performance can vary widely depending on contaminant type, fluid properties, flow rates and environmental conditions. It is recommended that users conduct thorough qualification testing to assure the product functions as required. For additional technical support, a product Performance Guide is available upon request.

DS\_GCTB\_190918

## GATB-Series Absolute Grade Meltblown Polypropylene

GATB-Series Absolute Grade Meltblown

Polypropylene Filter Cartridges:

- Precision process control of fiber diameter and layer density tunes the media to achieve targeted retention efficiency and ensure consistent performance.
- All polypropylene construction presents excellent compatibility with a wide range of chemicals.
- Resists contaminant unloading, even at elevated differential pressures.
- All end configurations available (glued or thermally-bonded).
- Grooved exterior increases surface area.
- Easy cartridge incineration and disposal.
- Free of additives, wetting agents, binders and silicone.



### Construction Materials

**Filtration Media**..... Polypropylene  
**End Caps**..... Polypropylene  
**O-Rings/Gaskets**..... Buna, EPDM, Polyfoam, Silicone, Viton®

### Operating Conditions

**Change Out ΔP (recommended)**.....35 PSID  
**Temperature (max)**.....140°F (60°C)  
**Differential Pressure (max)**.....50 PSID (3.4 bar) at 68°F (20°C)

### Flow Rate vs Pressure Drop

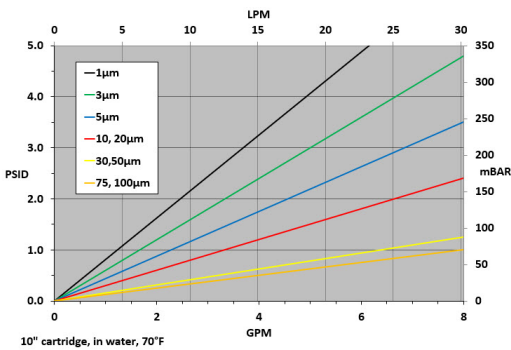

### Dimensions (Nominal)

**Length**.....9.75 to 40 inches (24.8 to 102 cm)  
**Outside Diameter**.....2.5 inches (6.4 cm)  
**Inside Diameter**.....1.06 inches (2.69 cm)

### Performance Specifications

**Micron Ratings:**  
 1, 3, 5, 10, 20, 30, 50, 75, 100  
**Efficiencies:**  
 1-3 Micron: 95%  
 5-100 Micron: 99%

### Food Safety Compliance

Materials of construction comply with FDA regulations for food and beverage contact use as detailed in the US Code of Federal Regulations, 21CFR. Materials used to produce filter media and hardware are deemed safe for use in contact with foodstuffs in accordance with EU Directives 2002/72/EC, 1935/2004, and/or 10/2011.



NSF Certification applies for use only with drinking water. Only products bearing the NSF Mark on the product, product packaging, and/or documentation shipped with the product are Certified. Product options denoted with asterisk (\*) are not included in the Certification.

### Ordering Information

GATB	Rating (μ)	A	Length	-	End Cap Style	O-Rings/Gaskets	-	Adders
Absolute Grade	1		9.75" (24.76cm)		Blank = None	Blank = None		Blank = Glued or None
	3		9.875" (25.08 cm)		2 = DOE Flat Gasket	B = Buna		CS = 316SS Compression Spring (TB ONLY)
	5		10" (25.4 cm)		3 = 222 w/Fin	E = EPDM		PC = Polypropylene Core
	10		19.5" (49.53 cm)		4 = 222 w/Flat Cap	P = Polyfoam (Gaskets) *		TB = Thermally-Bonded
	20		20" (50.8 cm)		5 = 222 w/Spring	S = Silicone		
	30		29.25" (74.29 cm)		6 = 226 w/Flat Cap	V = Viton®*		
	50		29.5" (74.93 cm)		7 = 226 w/Fin			
	75		30" (76.2 cm)		8 = 226 w/Spring			
	100		39" (99.1 cm)		9 = SOE w/ Spring			
			40" (101.6 cm)		10 = DOE w/PP Core Extender			
					20 = SOE PP Ext. w/Spring			

DISCLAIMER: Filtration data presented is representative of performance observed in controlled laboratory testing. It is not given as a warranty, specification or statement of fitness for use. Specific performance can vary widely depending on contaminant type, fluid properties, flow rates and environmental conditions. It is recommended that users conduct thorough qualification testing to assure the product functions as required. For additional technical support, a product Performance Guide is available upon request.

DS\_GATB\_190918

## GRU-V Series Resin Bonded

The unique manufacturing process of GRU-V filter elements produces a rigid fixed-matrix structure with true graded-porosity. This maximizes contaminant-holding capacity while preventing the unloading behavior that is often problematic in competitive products. The grooved outer surface greatly expands the filter's effective surface area and further increases the contaminant holding capacity. The synthetic fiber/phenolic resin binder offers well-proven performance operating under challenging conditions of high temperatures, high fluid viscosities, and high differential pressures. The GRU-V is ideal for paints, coatings, oils, and many other demanding applications.



### Flow Rate vs Pressure Drop

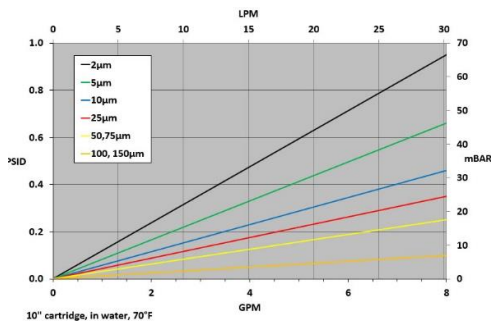

### Typical Applications

- Coatings
- Epoxies
- Adhesives
- Sealants
- Hydraulic Fluids
- Lubricating Oils
- Greases
- Paints
- Inks

### Dimensions

- Lengths**.....9.75 to 40 inches  
(24.77 to 101.6cm)
- Outside Diameter**.....2.56 inches (6.50cm)
- Inside Diameter**.....1.06 inches (2.69cm)

### Construction Materials

Polyester & acrylic fibers with phenolic resin encapsulation.

### Features

- Micron ratings from 2 to 150
- True graded-porosity structure for high dirt holding
- Broad chemical compatibility
- Rigid construction ideal for high viscosity uses
- High temperature resistance

### Operating Conditions

<b>Maximum Operating Temperature</b>	Standard DOE 250°F (121°C)
	w/ Polypropylene Spring or Core Extender 180°F (82°C)
	High Temperature DOE (HT) 300°F (149°C)
<b>Maximum Operating Differential Pressure</b>	w/ Stainless Steel Core Extender (HT) 300°F (149°C)
	90 PSID at 150°F (65°C)
<b>Recommended Change-out Differential Pressure</b>	35 PSID

### Ordering Information

GRU-V	Rating (µ)	N	Length	-	Option	End Cap Style	-	Adders
	2		9.75" (24.77cm)		Blank = Standard	Blank = No End Configuration (DOE)		B = Micron Brand
	5		10" (25.40 cm)		HT = High Temp	9 = SOE w/Poly Spring		
	10		19.5" (49.53 cm)			10 = DOE w/Poly Core Ext.		
	25		20" (50.80 cm)			10X = Stainless Steel Core Ext.		
	50		29.25" (74.26 cm)			20 = SOE w/Poly Core Ext. & Poly Spring		
	75		30" (76.20 cm)					
	100		39" (99.06 cm)					
	125		40" (101.60 cm)					
	150							

DISCLAIMER: Filtration data presented is representative of performance observed in controlled laboratory testing. It is not given as a warranty, specification or statement of fitness for use. Specific performance can vary widely depending on contaminant type, fluid properties, flow rates and environmental conditions. It is recommended that users conduct thorough qualification testing to assure the product functions as required.

DS\_GRB\_190918



## G-Series Wound

G-Series Wound Depth Filter cartridges:

- Available in a wide variety of lengths and micron ratings from 9.75 to 50 inches and 0.5-400  $\mu$
- Medias to fit all applications including: FDA polypropylene, bleached cotton, FDA bleached cotton, natural cotton, polyester, nylon and glass
- Core materials include: polypropylene, 304 & 316 stainless steel, tin and glass
- Performance-enhancing end-configurations available to fit every process requirement



### Flow Rate vs Pressure Drop

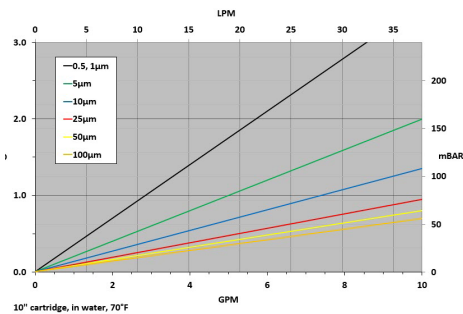

### Construction Materials

**Filtration Media**..... See Table  
**End Caps**..... Polypropylene  
**Core**..... See Table  
**O-Rings/Gaskets**..... Buna, EPDM, Silicone, Teflon®, Viton®

### Operating Conditions

**Change Out  $\Delta$ P (recommended)**.....35 PSID  
**Temperature (max)**..... Dependent on materials of construction  
**Differential Pressure (max)**.....50 PSID (3.4 bar) at 68°F (20°C)

### Dimensions (Nominal)

**Length**.....9.75 to 50 inches (24.8 to 127 cm)  
**Outside Diameter**.....2.5 inches (6.4 cm) or 4.5 inches (11.4 cm)  
**Inside Diameter**.....1.06 inches (2.69 cm)

### Typical Applications

- Chemicals
- Pharmaceutical
- Consumer Products
- Photographic
- Food and Beverage
- Plating Solutions
- Lubricating Oils
- Edible Oils
- Paints
- Water
- Inks
- Waste Treatment
- Petrochemicals

### Ordering Information

G	Media	Rating ( $\mu$ )	Diameter	Length	Core	End Cap Style	O-Rings
	P = FDA Polypropylene	0.5	A = 2.5	9.75" (24.76cm)	P = Polypro	2P= DOE Flat Polyfoam Gasket	B = Buna
	C = Bleached Cotton	1	BB = 4.5	9.875" (25.08 cm)	A = 304 SS	3 = 222 w/Fin	E = EPDM
	CC = FDA Bleached Cotton	3		10" (25.4 cm)	S = 316 SS	4 = 222 w/Flat Cap	S = Silicone
	CN = Natural Cotton	5		19.5" (49.53 cm)	T = Tin	5 = 222 w/Spring	T = Teflon®
	PE = Polyester	10		20" (50.8 cm)	FG = Glass	6 = 226 w/Flat Cap	V = Viton®
	N = Nylon	20		29.25" (74.26 cm)		7 = 226 w/Fin	
	G = Glass	25		30" (76.2 cm)		8 = 226 w/Spring	
		30		39" (99.1 cm)		9 = SOE w/ Spring	
		50		40" (101.6 cm)		10 = DOE w/PP Core Extender	
		75		50" (127 cm)		10K = DOE w/ Crimped Ext. Core	
		100				10X = DOE w/ SS Core Extender	
		200					
		250					
		400					

DISCLAIMER: Filtration data presented is representative of performance observed in controlled laboratory testing. It is not given as a warranty, specification or statement of fitness for use. Specific performance can vary widely depending on contaminant type, fluid properties, flow rates and environmental conditions. It is recommended that users conduct thorough qualification testing to assure the product functions as required.

DS\_G WOUND\_191223



## LIQUID FILTER BAGS

Adaptable to a very wide range of applications, liquid bag filters are available in both nominal and high efficiency designs in micron ratings from 1 to 1500.

## Standard Felt Liquid Filter Bags

- Micron ratings from 1 to 200
- All industry-standard and custom sizes available
- Broad chemical compatibility
- High flow/low pressure drop media
- Sewn or fully-welded construction
- Handles standard on all bags
- Choice of steel or molded plastic snap seal rings
- Temperature ratings to 275°F (PE w/S, SS or V-seal ring) and 425°F (HT w/S or SS ring)

### Felt Bag Materials

Constructed with 100% synthetic fibers in polypropylene, polyester and Nomex®. The proper combination of fiber diameters, weights and thicknesses result in economical depth filter medias. Polypropylene & polyester bags are supplied with a singed or glazed finish to reduce fiber migration.

- Polypropylene, Polyester and Nomex materials meet FDA regulations for food contact under CFR21, Section 177.1520
- Glazed/singed finish on polyester & polypropylene reduces fiber-shedding
- Ability to remove both solid and gelatinous particles
- Silicone-free construction
- High dirt holding capacity
- Low cost

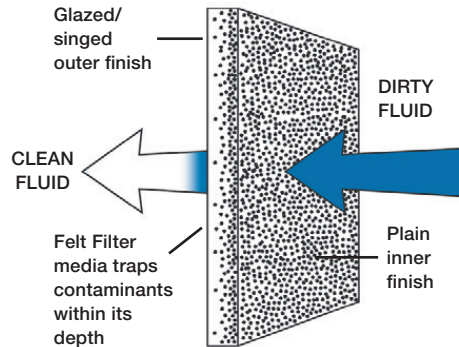

### Felt Bag Styles

S-ring bags have a galvanized steel ring (stainless steel optional) sewn into the top of the bag. They are supplied with sewn seams standard. V-ring bags have a specially-designed, high-temperature snap seal ring sewn into the top of the bag. They are supplied with sewn seams standard (fully-welded seams available upon request).

### Welded Construction

Fully-welded bags are available in glazed polypropylene and singed polyester felt, in #1 & #2 sizes with V-seal molded plastic rings.

- No needle holes, thus increasing efficiencies by preventing by-pass
- Elimination of threads further reduces fiber-shedding

Felt Materials	Rating (μ)											
	1	3	5	10	15	25	50	75	100	150	200	
Polyester	•	•	•	•	•	•	•	•	•	•	•	
Polypropylene	•	•	•	•		•	•		•		•	
Nomex®	•		•	•		•	•	•	•		•	

### Ordering Information

G	Media	Rating (μ)	Cover/Jacket	Bag Dimensions			Ring Style	Options
	PE = Polyester	1-200	P = Plain (No Cover)	Size	Diam.	Length	C = Commercial-Style Band (C1 & C2 only)	A = Automotive Seam
	PO = Polypropylene		PEM = Polyester Multifilament Mesh	1	7.06	16.5"	PP = Polypropylene (rolled)	NR = No Ring
	HT = Nomex®			2	7.06	32.0"	S = Galvanized Steel	PL = No Outer Finish
				3	4.12	8.0"	SS = Stainless Steel	RC = Rev. Collar (S & SS only)
				4	4.12	14.0"	V = High-temp Plastic Snap Seal	WE = Fully-Welded (PE and PO Only)
				7	5.5	15.0"		
				8	5.5	20.0"		
				9	5.5	31.0"		
				C1	7.31	16.5"		
				C2	7.31	32.5"		
				12	8.0	30.0"		

DISCLAIMER: Filtration data presented is representative of performance observed in controlled laboratory testing. It is not given as a warranty, specification or statement of fitness for use. Specific performance can vary widely depending on contaminant type, fluid properties, flow rates and environmental conditions. It is recommended that users conduct thorough qualification testing to assure the product functions as required.

DS\_GPE-GPO\_190918

## Standard Mesh Liquid Filter Bags

- Micron ratings from 1 to 1500
- All industry-standard and custom sizes available
- High flow/low pressure drop media
- Surface-retention filtration
- Wide chemical compatibility
- Sewn construction
- Handles standard on all bags
- Non-fiber shedding
- High removal efficiency
- Temperature ratings to 400°F (204°C)
- Silicone-free construction
- Economical removal of non-deformable contaminants
- Choice of steel or molded plastic snap seal rings
- Meet FDA regulations for contact under Title 21, Section 177.1520

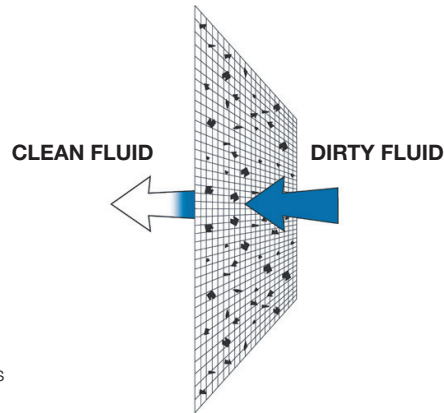

### Mesh Bag Styles

S-ring bags have a galvanized steel ring (stainless steel optional) sewn into the top of the bag. They are supplied with sewn seams standard. V-ring bags have a specially-designed, high-temperature snap seal ring sewn into the top of the bag. They are supplied with sewn seams standard.

### Mesh Bag Materials



**Multifilament** Mesh media is woven from threads made of smaller fibers. Bags made from this material are low cost and disposable.



**Monofilament** Mesh is woven from single-fiber threads. The openings are square and uniform. Bags made from this material have excellent strength and some are cleanable.

Mesh Materials	Rating (µ)																	
	1	5	10	25	50	75	100	125	150	175	200	250	300	400	600	800	1000	1500
NMO	•	•	•	•	•	•	•	•	•	•	•	•	•	•	•	•	•	•
POMO							•		•									
PEMU/NMU							•		•									•

### Ordering Information

G	Media	Rating (µ)	Cover/Jacket	Bag Dimensions			Ring Style	Options
	NMO = Nylon Monofilament	1-1500	P = Plain (No Cover)	Size	Diam.	Length	C = Commercial Type Snap Steel Band	A = Automotive Seam
	POMO = Polypropylene Monofilament			1	7.06	16.5"	PP = Polypropylene (rolled)	DS = Draw-String
	PEMU = Polyester Multifilament			2	7.06	32.0"	S = Standard Steel Ring	EB = Edge Binding
	NMU = Nylon Multifilament			3	4.12	8.0"	SS = Stainless Steel Ring	NR = No Ring
				4	4.12	14.0"	V = High-temp Plastic Snap Seal	RC = Rev. Collar (S & SS only)
				7	5.5	15.0"		
				8	5.5	20.0"		
				9	5.5	31.0"		
				C1	7.31	16.5"		
				C2	7.31	32.5"		
				12	8.0	30.0"		

DISCLAIMER: Filtration data presented is representative of performance observed in controlled laboratory testing. It is not given as a warranty, specification or statement of fitness for use. Specific performance can vary widely depending on contaminant type, fluid properties, flow rates and environmental conditions. It is recommended that users conduct thorough qualification testing to assure the product functions as required.

DS\_GN-GP\_190918

## Microfiber Liquid Filter Bags

### High Efficiency Microfiber Filter Bags

Micron ratings from 1.0 to 50.0

All industry-standard and custom sizes available

Choice of steel or molded plastic snap seal V-rings

Broad chemical compatibility

Excellent oil-absorbing capabilities (POMF)

Handles standard on all bags

Efficiency ratings to 95.0%

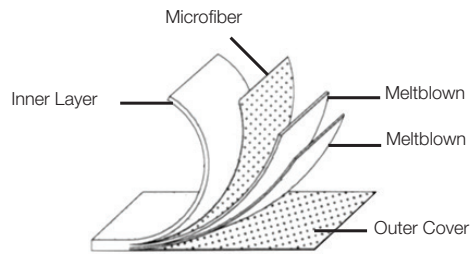

HIGH EFFICIENCY FILTER BAG



### High Efficiency Bag Materials

Microfiber materials provide high efficiencies at low micron ratings. Multi-layer technology results in true graded-density filtration, delivering significantly increased loading capacities and lower overall filtration costs.

- Polypropylene & polyester microfiber materials meet FDA regulations for food contact under CFR21, Section 177.1520
- Silicone-free construction
- High dirt holding capacity

### High Efficiency Bag Styles

- Standard ring bags have a galvanized steel ring (stainless steel optional) sewn in the top of the bag
- V-ring bags have a molded plastic ring sewn to the filter bag

High Efficiency Materials (95.0%)	Rating (μ)					
	1A	2A	5A	10A	25A	50A
Polyester	•	•	•	•	•	•
Polypropylene	•	•	•	•	•	•

### Ordering Information

G	Media	Rating (μ)	Cover/Jacket	Bag Dimensions			Ring Style
				Size	Diam.	Length	
	PEMF = Polyester	1A	P = Standard	1	7.06	16.5"	C = Commercial-Style Band (C1 & C2 only)
	POMF = Polypropylene	2A		2	7.06	32.0"	PP = Polypropylene (rolled)
		5A		3	4.12	8.0"	S = Standard Steel Ring
		10A		4	4.12	14.0"	SS = Stainless Steel Ring
		25A		7	5.5	15.0"	V = High-temp Plastic Snap Seal
		50A		8	5.5	20.0"	
				9	5.5	31.0"	
				C1	7.31	16.5"	
				C2	7.31	32.5"	

DISCLAIMER: Filtration data presented is representative of performance observed in controlled laboratory testing. It is not given as a warranty, specification or statement of fitness for use. Specific performance can vary widely depending on contaminant type, fluid properties, flow rates and environmental conditions. It is recommended that users conduct thorough qualification testing to assure the product functions as required.

DS\_GPEMF-GPOMF\_190918



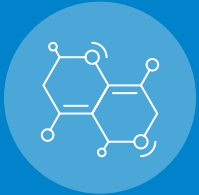

## FILTER VESSELS

Global Filter's vessels meet the process requirements for the broadest range of applications and industries. With robust construction, these are available constructed in 304 & 316 stainless steel as well as carbon steel, for flow rates up to 2,400 GPM. Designs are available stamped as compliant with the ASME Code for Boilers and Pressure Vessels, and registered with the National Board and are available with the European Union CE Mark. In addition, many of our designs meet NSF 61 requirements for drinking water.

## GFHD-Series Single-Cartridge Liquid Filter Vessels

GFHD-Series Single-Cartridge Vessels are suited for a wide variety of filtration applications. A ring-nut closure provides easy access for change-out. Rated for 300 PSI service, models are available in either 304 or 316 stainless steel construction.

### Features

- DOE design features a spring-loaded bottom seat cup which allows for easy installation and positive seal
- Ring-nut allows for easy change-out (wrench pin is included as standard, spanner wrench is optional)
- 3/4" and 1" inlet and outlet available in NPT and BSPP for ease of installation
- 1/4" NPT dirty drain port allows for complete evacuation prior to change-out
- Available in 5", 10", 20", 30" lengths to accept cartridges up to 3" OD
- 304 or 316 stainless steel construction (passivated finish)
- Offered in DOE, 222/FLAT\* or 226/FLAT\* configurations
- Heavy-duty cast head with mounting bracket
- Dual closure seal (EPDM standard)
- 300 PSI pressure rating
- Inline port design

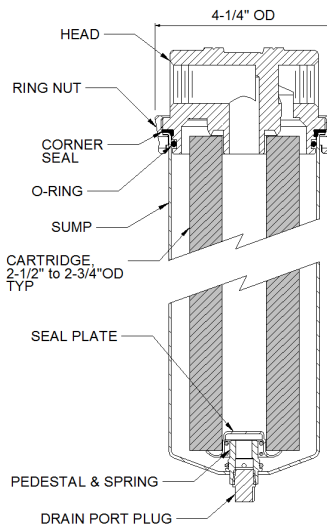

### Alternate Seal Materials (Sold Separately)

- Viton®\*
- Buna
- Teflon® Encapsulated Viton®\*



NSF Certification applies for use only with drinking water. Only products bearing the NSF Mark on the product, product packaging, and/or documentation shipped with the product are Certified. Product options denoted with asterisk (\*) are not included in the Certification.

Certified to NSF/ANSI/CAN 61

### Ordering Information

GFHD1	Length	Inlet/Outlet Size	End Configuration	Material	Pressure Rating	NSF
	05 = 5"	75N = 3/4" FNPT	D = DOE	4 = 304 SS	30 = 300 PSI	Blank = None
	1 = 10"	1N = 1" FNPT	2 = 222/FLAT*	6 = 316 SS		MC = NSF-61
	2 = 20"	75B = 3/4" BSPP**	6 = 226/FLAT*			
	3 = 30"	1B = 1" BSPP**				

\* Available in 316 SS only \*\* Available in 304 SS only

DISCLAIMER: Filtration data presented is representative of performance observed in controlled laboratory testing. It is not given as a warranty, specification or statement of fitness for use. Specific performance can vary widely depending on contaminant type, fluid properties, flow rates and environmental conditions. It is recommended that users conduct thorough qualification testing to assure the product functions as required.

DS\_GFHD\_190918

## GTCHB-Series Multi-Cartridge Band Clamp Liquid Filter Vessels

GTCHB-Series Multi-Cartridge Vessels are designed for industrial and commercial applications. Vessels are constructed of 304 or 316L stainless steel and accept DOE, 222/FLAT and 222/FIN end cartridges in 10, 20, 30 & 40 inch lengths.

### Features

- Easy access, self-centering heavy-duty band-clamp closure
- Heavy-duty welded mounting/support legs
- Single o-ring design (Buna standard)
- Universal seal cups and compression plates allow vessels to accept DOE, 222/FLAT or 222/FIN cartridges
- Poly-coat finish (exterior only)
- 316L stainless steel cap/spring assemblies and V-posts
- 150 PSI pressure rating

### Options

- Electropolished Finish
- Sanitary Porting
- Alternate Seal Materials
  - EPDM (required for NSF-61)
  - Teflon® Encapsulated Viton® ✱
  - Viton® ✱

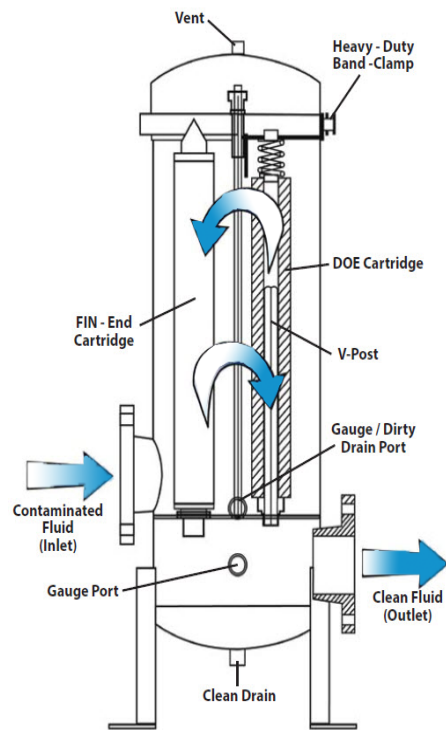
 Certified to  
 NSF/ANSI/CAN 61

NSF Certification applies for use only with drinking water. Only products bearing the NSF Mark on the product, product packaging, and/or documentation shipped with the product are Certified. Product options denoted with asterisk (✱) are not included in the Certification.

### Ordering Information

GTCHB	# of Cartridges	Length	Inlet/Outlet Size	Inlet/Outlet Style	Outlet	Material	Pressure Rating	Surface Finish	NSF
	4	1 = 10"	2 = 2", (50)	B = BSPT	2 = Opposite Outlet	4 = 304 SS	15 = 150 PSI @ 250°F	PC = Poly-coat	Blank = None
	5	2 = 20"	3 = 3", (80)	DN = DIN Flange		6 = 316L SS			MC = NSF-61
	7	3 = 30"	4 = 4", (100)	F = RF Flange					
	12	4 = 40"		M = MNPT					
	22								

DISCLAIMER: Filtration data presented is representative of performance observed in controlled laboratory testing. It is not given as a warranty, specification or statement of fitness for use. Specific performance can vary widely depending on contaminant type, fluid properties, flow rates and environmental conditions. It is recommended that users conduct thorough qualification testing to assure the product functions as required.

DS\_GTCHB\_190918

## GTCH-Series Multi-Cartridge Liquid Filter Vessels

GTCH-Series Multi-Round Cartridge Vessels are designed for industrial and high purity applications. Vessels are constructed of 304 or 316L stainless steel and accept DOE, 222/FLAT and 222/FIN end cartridges in 10, 20, 30 & 40 inch lengths.

### Features

- 304 or 316L stainless steel construction options
- 150 PSI pressure rating standard
- Single o-ring design (Buna standard)
- Easy-access eye-nuts/swing-bolt closure
- Universal seat cups and alternate compression/hold-down plates allow vessels to accept DOE, 222/FLAT or 222/FIN cartridges
- Heavy-duty welded angle mounting/support legs
- Bearing-assisted hand-wheel closure davit (GTCH12 & larger)

### Options

- ASME Code Stamp
- CE Mark
- Electropolished Finish
- Sanitary Porting
- Alternate Seal Materials
  - EPDM (required for NSF-61)
  - Teflon® Encapsulated Viton® \*
  - Viton® \*

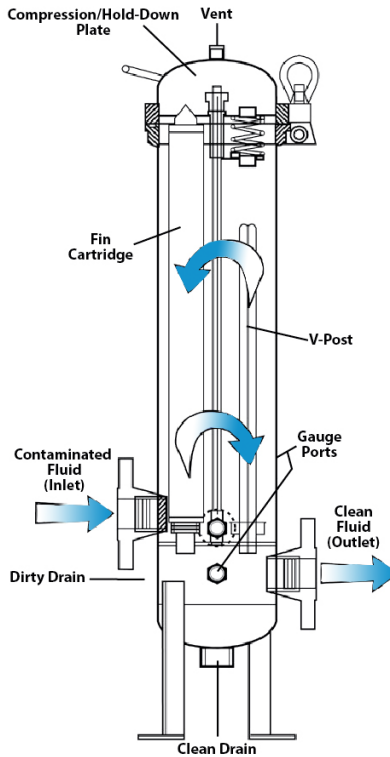
 Certified to  
 NSF/ANSI/CAN 61

NSF Certification applies for use only with drinking water. Only products bearing the NSF Mark on the product, product packaging, and/or documentation shipped with the product are Certified. Product options denoted with asterisk (\*) are not included in the Certification.

### Ordering Information

GTCH	# of Cartridges	Length	Inlet/Outlet Size	Inlet/Outlet Style	Outlet	Material	Pressure Rating	Surface Finish	ASME Stamp CE Mark	NSF
	3	1 = 10"	1 = 1", (25)	B = BSPT	1 = Bottom Outlet	4 = 304 SS	15 = 150 PSI @ 250°F	EP = Electropolished	Blank = None	Blank = None
	5	2 = 20"	1.5 = 1.5", (40)	DN = DIN	2 = Opposite Outlet	6 = 316L SS		GB = Glass Bead	U = ASME	MC = NSF-61
	7	3 = 30"	2 = 2", (50)	F = RF Flange					CE = CE Mark	
	12	4 = 40"	3 = 3", (80)	N = FNPT						
	21		4 = 4", (100)	T = TC ferrule						
	36		6 = 6", (50)							
	51		8 = 8", (200)							

DISCLAIMER: Filtration data presented is representative of performance observed in controlled laboratory testing. It is not given as a warranty, specification or statement of fitness for use. Specific performance can vary widely depending on contaminant type, fluid properties, flow rates and environmental conditions. It is recommended that users conduct thorough qualification testing to assure the product functions as required.

DS\_GTCH\_190918

## GBFE4-Series Single Bag Liquid Filter Vessels

GBFE4 Series Bag Vessels offer an economical solution to your low-flow bag filtration requirements. These vessels offer a cost-effective means for removing solid contaminants from a process liquid stream. Vessels are designed to a 300 PSI rating with a swing bolt closure. Vessels accept (1) #4-size filter bag.

### Features

- 304 stainless steel construction with a glass bead finish
- 300 PSIG rating
- Buna seal
- Easy-access swing-bolt closure
- 1" NPT uni-style (side & bottom outlet) offers increased piping flexibility
- Stainless steel hold-down spring
- 1/4" NPT vent & gauge ports
- Adjustable stainless steel tripod mounting/support leg assembly
- Stainless steel perforated support basket (9/64" perf. standard)

### Options

Alternate Seal Materials

- EPDM (required for NSF-61)
- Viton®\*



NSF Certification applies for use only with drinking water. Only products bearing the NSF Mark on the product, product packaging, and/or documentation shipped with the product are Certified. Product options denoted with asterisk (\*) are not included in the Certification.

Certified to NSF/ANSI/CAN 61

### Flow Rate

Model	Bag Size	Basket Depth	EFA (ft²)	Max Flow Rate (GPM)*
GBFE412	4	12	1.0	50

\* Is the maximum flow rate recommended through the vessel without a filter bag installed (using water). Any increase in viscosity and/or the installation of filter bags will reduce these flow rates significantly. Please refer to the appropriate bag filter sizing chart or consult with your Global Filter representative when sizing.

### Ordering Information

GBFE4	Basket Depth	Inlet/Outlet Size	Outlet	Material	Pressure Rating	Surface Finish	NSF
	12 = #4 Size	1N = 1" FNPT	3 = Bottom & Opposite Side	4 = 304 SS	30 = 300 PSI @ 250°F	GB = Glass Bead	Blank = None
		1B = 1" BSPT					MC = NSF-61

DISCLAIMER: Filtration data presented is representative of performance observed in controlled laboratory testing. It is not given as a warranty, specification or statement of fitness for use. Specific performance can vary widely depending on contaminant type, fluid properties, flow rates and environmental conditions. It is recommended that users conduct thorough qualification testing to assure the product functions as required.

DS\_GBFE4\_190918



## GBFV8-Series Stainless Steel & Carbon Steel Single Bag Liquid Vessels

GBFV8-Series Stainless Steel & Carbon Steel Bag Vessels are designed to meet and/or exceed nearly all application requirements. The V-ring design provides a positive snap-fit to ensure against bypass and deliver clean effluent.

### Features

- BSP, NPT, or RF Flanged inlet/outlet connections
- Stainless steel or carbon steel construction with epoxy coated exterior support baskets (9/64" standard)
- Adjustable tripod mounting/support leg assemblies
- Easy-access eye-nut/swing-bolt closures with handle
- 304 or 316L stainless steel construction options uni-style (side & bottom outlet) offers increased piping flexibility
- 2" NPT uni-style (side & bottom outlet) offers increased piping flexibility
- Single o-ring seal (Buna-N standard)
- 150 PSI pressure rating standard
- Snap-fit V-ring bag seal design

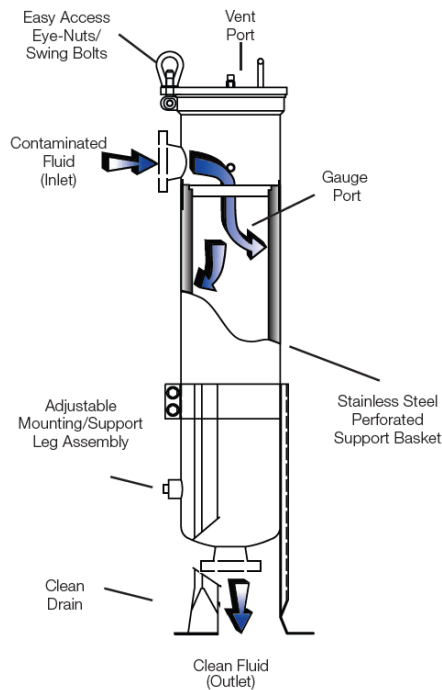

### Options

- ASME Code Stamp (SS only)
- CE Mark (SS only)
- Electropolished Finish
- Sanitary porting
- Mesh-lined/perforated baskets
- Alternate seal materials
  - EPDM (required for NSF-61)
  - Silicone



NSF Certification applies for use only with drinking water. Only products bearing the NSF Mark on the product, product packaging, and/or documentation shipped with the product are Certified. Product options denoted with asterisk (\*) are not included in the Certification.

### Flow Rate

Model	Bag Size	Basket Depth	EFA (ft <sup>2</sup> )	Max Flow Rate (GPM)*
GBFV815	#1	15	2.0	90
GBFV830	#2	30	4.4	200

\* Is the maximum flow rate recommended through the vessel without a filter bag installed (using water). Any increase in viscosity and/or the installation of filter bags will reduce these flow rates significantly. Please refer to the appropriate bag filter sizing chart or consult with your Global Filter representative when sizing.

### Ordering Information - Carbon Steel

GBFV8	Basket Depth	Inlet/Outlet Size	Inlet/Outlet Style	Outlet	Material	Pressure Rating	Surface Finish
	15 = #1 Size	2 = 2"	B = BSPT	1 = Bottom Outlet	C = Carbon Steel*	15 = 150 PSI @ 500°F	EC = Epoxy Coated
	30 = #2 Size	3 = 3"	DN = DIN flange	2 = Opposite Side			
			F = RF Flange	3 = Bottom & Opposite			
			N = FNPT				

### Ordering Information - Stainless Steel

GBFV8	Basket Depth	Inlet/Outlet Size	Inlet/Outlet Style	Outlet	Material	Pressure Rating	Surface Finish	ASME Stamp CE Mark	NSF
	15 = #1 Size	2 = 2"	B = BSPT	1 = Bottom Outlet	4 = 304SS	15 = 150 PSI @ 250°F	EP = Electropolished	Blank = None	Blank = None
	30 = #2 Size	3 = 3"	DN = DIN flange	2 = Opposite Side	6 = 316SS		GB = Glass Bead	U = ASME	MC = NSF-61
			F = RF Flange	3 = Bottom & Opposite				CE Mark (SS only)	
			N = FNPT						
			T = TC Ferrule						

Specific performance can vary widely depending on contaminant type, fluid properties, flow rates and environmental conditions. It is recommended that users conduct thorough qualification testing to assure the product functions as required\*\* MC only applies to the 304 & 316ss and not to the carbon steel construction.

DS\_GBfV8\_190918

## GBFV82-Series Twin Capacity Bag Liquid Filter Vessels

GBFV82-Series Twin-Capacity Bag Vessels are designed to meet and/or exceed nearly all application requirements. The V-ring design provides a positive snap-fit to ensure against by-pass and deliver clean effluent. Vessels offer the flow and loading capacity of a multi-bag vessel at a more economical cost.

### Features

- 304 or 316L stainless steel construction options
- 150 PSI pressure rating standard
- Snap-fit V-ring bag seal design
- Single o-ring seal (Buna standard)
- Two identical GBFV830 vessels working in tandem
- Adjustable tripod mounting/support leg assemblies
- High flow rates and loading capacity at low pressure drops
- Stainless steel support baskets (9/64" standard)
- Two easy-access eye-nut/swing-bolt closures with single handle
- RF or DIN Flanged inlet/outlet connections (same side and opposite side options available)

### Options

- ASME Code Stamp
- Electropolished finish
- Mesh-lined/perforated baskets
- Alternate seal materials
  - EPDM (required for NSF-61)
  - Teflon® Encapsulated Viton®\*
  - Viton®\*



NSF Certification applies for use only with drinking water. Only products bearing the NSF Mark on the product, product packaging, and/or documentation shipped with the product are Certified. Product options denoted with asterisk (\*) are not included in the Certification.

Certified to NSF/ANSI/CAN 61

### Flow Rate

Model	Bag Size	Basket Depth	EFA (ft <sup>2</sup> )	Max Flow Rate (GPM)*
GBFV8230	#2	30	8.8	400

\* Is the maximum flow rate recommended through the vessel without a filter bag installed (using water). Any increase in viscosity and/or the installation of filter bags will reduce these flow rates significantly. Please refer to the appropriate bag filter sizing chart or consult with your Global Filter representative when sizing.

### Ordering Information

GBFV82	Basket Depth	Inlet/Outlet Size	Inlet/Outlet	Outlet	Material	Pressure Rating	Surface Finish	ASME Code Stamp/CE Mark	NSF
	30 = #2 Size	3 = 3"	DN = DIN flange	2 = Opposite Side	4 = 304 SS	15 = 150 PSI @ 250°F	EP = Electropolished	Blank = None	Blank = None
		4 = 4"	F = RF Flange	5 = Same Side	6 = 316L SS		GB = Glass Bead	U = ASME	MC = NSF-61

DISCLAIMER: Filtration data presented is representative of performance observed in controlled laboratory testing. It is not given as a warranty, specification or statement of fitness for use. Specific performance can vary widely depending on contaminant type, fluid properties, flow rates and environmental conditions. It is recommended that users conduct thorough qualification testing to assure the product functions as required.

DS\_GBFFV82\_190918

## GMBV-Series Multi-Bag Liquid Vessels

GMBV-Series Multi-Bag Vessels are designed for high flow and/or high contaminant load applications where clean effluent is critical. The V-ring design provides a positive snap-fit to ensure against by-pass.

### Features

- Heavy-duty welded angle mounting/support legs
- RF Flanged "inline" inlet/outlet connections
- Bearing-assisted hand-wheel closure
- Permanent compression/hold-down plate
- Stainless steel support baskets (9/64" standard)
- Easy-access eye-nut/swing-bolt closure
- 304 or 316 stainless steel construction
- Snap-fit V-ring bag seal design
- 150 PSI pressure rating
- Single o-ring seal (Buna-N standard)

### Options

- ASME Code Stamp
- CE Mark (SS only)
- Mesh-lined/perforated baskets
- Alternate Seal Materials
  - EPDM (required for NSF-61)
  - Teflon® Encapsulated Viton®\*
  - Viton®\*

 Certified to  
 NSF/ANSI/CAN 61

NSF Certification applies for use only with drinking water. Only products bearing the NSF Mark on the product, product packaging, and/or documentation shipped with the product are Certified. Product options denoted with asterisk (\*) are not included in the Certification.

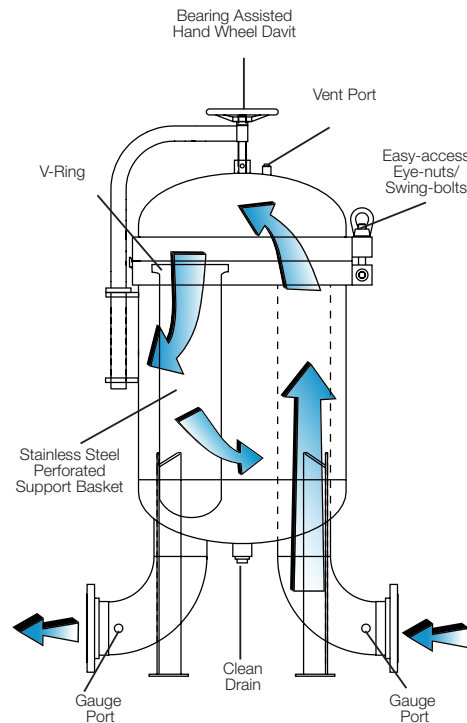

### Flow Rate

Model	# of Bags	Bag Size	Basket Depth	EFA (ft <sup>2</sup> )	Max Flow Rate (GPM)*
GMBV430	4	#2	30"	17.6	600
GMBV630	6	#2	30"	26.4	1200
GMBV830	8	#2	30"	35.2	1600
GMBV1230	12	#2	30"	57.8	2400

\* Is the maximum flow rate recommended through the vessel without a filter bag installed (using water). Any increase in viscosity and/or the installation of filter bags will reduce these flow rates significantly. Please refer to the appropriate bag filter sizing chart or consult with your Global Filter representative when sizing.

### Ordering Information

GMBV	# of Bags/Baskets	Basket Depth	Inlet/Outlet Size	Inlet/Outlet	Material	Pressure Rating	Surface Finish	ASME Code Stamp/CE Mark	NSF
	4	30 = 30"	4 = 4"	DN = DIN flange	4 = 304 SS	15 = 150 PSI @ 250°F	GB = Glass Bead	Blank = None	Blank = None
	6		6 = 6"	F = RF Flange	6 = 316 SS			U = ASME	MC = NSF-61
	8		8 = 8"					CE = CE Mark	
	12								

DISCLAIMER: Filtration data presented is representative of performance observed in controlled laboratory testing. It is not given as a warranty, specification or statement of fitness for use. Specific performance can vary widely depending on contaminant type, fluid properties, flow rates and environmental conditions. It is recommended that users conduct thorough qualification testing to assure the product functions as required.

DS\_GMBV\_190918

## GMBE-Series Stainless & Carbon Steel Multi-Bag Liquid Vessels

GMBE-Series Stainless & Carbon Steel Multi-Bag Liquid Vessels are designed to offer a high-quality and economical solution for a variety of high flow and high load applications. The V-ring tubesheet design provides a positive snap-fit to ensure against by-pass.

### Features

- 304, 316L Stainless Steel and Carbon Steel construction
- Epoxy-coated exterior (CS only)
- 150 PSI pressure rating
- RF or DIN Flanged "inline" inlet/outlet connections
- Snap-fit V-ring bag seal design
- Stainless steel perforated support baskets (9/64" perf. standard)
- Permanent compression/hold-down plate
- Heavy-duty welded angle mounting/support legs
- Easy-access eye-nut/swing-bolt closure with bearing-assisted hand-wheel davit
- Single o-ring seal (Buna-N standard)
- Mesh-lined/perforated baskets

### Options

- Mesh-lined/perforated baskets
- Alternate seal materials
  - EPDM (required for NSF-61)
  - Teflon® Encapsulated Viton®\*
  - Viton®\*



NSF Certification applies for use only with drinking water. Only products bearing the NSF Mark on the product, product packaging, and/or documentation shipped with the product are Certified. Product options denoted with asterisk (\*) are not included in the Certification.



### Flow Rate

Model	# of Bags	Bag Size	Basket Depth	EFA (ft²)	Max Flow Rate (GPM)*
GMBE430	4	#2	30"	17.6	600
GMBE630	6	#2	30"	26.4	1200
GMBE830	8	#2	30"	35.2	1600
GMBE1230	12	#2	30"	57.8	2400

\* Is the maximum flow rate recommended through the vessel without a filter bag installed (using water). Any increase in viscosity and/or the installation of filter bags will reduce these flow rates significantly. Please refer to the appropriate bag filter sizing chart or consult with your Global Filter representative when sizing.

### Ordering Information

GMBE	# of Bags/ Baskets	Basket Depth	Inlet/Outlet Size	Inlet/Outlet	Material	Pressure Rating	Surface Finish	NSF
	4	30 = 30"	4 = 4"	DN = DIN flange	4 = 304 SS	15 = 150 PSI @ 250°F	EC = Epoxy Coated Exterior (CS Only)	Blank = None
	6		6 = 6"	F = RF Flange	6 = 316L SS		GB = Glass Bead (SS Only)	
	8		8 = 8"		C = Carbon Steel *			
	12							

DISCLAIMER: Filtration data presented is representative of performance observed in controlled laboratory testing. It is not given as a warranty, specification or statement of fitness for use. Specific performance can vary widely depending on contaminant type, fluid properties, flow rates and environmental conditions. It is recommended that users conduct thorough qualification testing to assure the product functions as required.

DS\_GBFV-GMBE\_190918



Global Filter's keen attention to cleanliness and process control is instrumental in our ability to deliver quality and consistent product performance. We deliver the best net value in industries we serve.







---

#### ADDRESS

##### **Global Filter**

7201 Mt. Vernon Rd. SE  
Cedar Rapids, IA 52403 USA



---

#### CONTACT

##### **Phone & Fax**

Phone: + 1 877 603 1003  
Fax: + 1 319 743 0220

##### **Online**

Email: [gfcustomerservice@filtrationgroup.com](mailto:gfcustomerservice@filtrationgroup.com)  
Website: [www.globalfilter.com](http://www.globalfilter.com)



**Filtration Group®**  
Filtering The World